

Documentation | EN

# EK110x-00xx, EK15xx

EtherCAT Bus Coupler

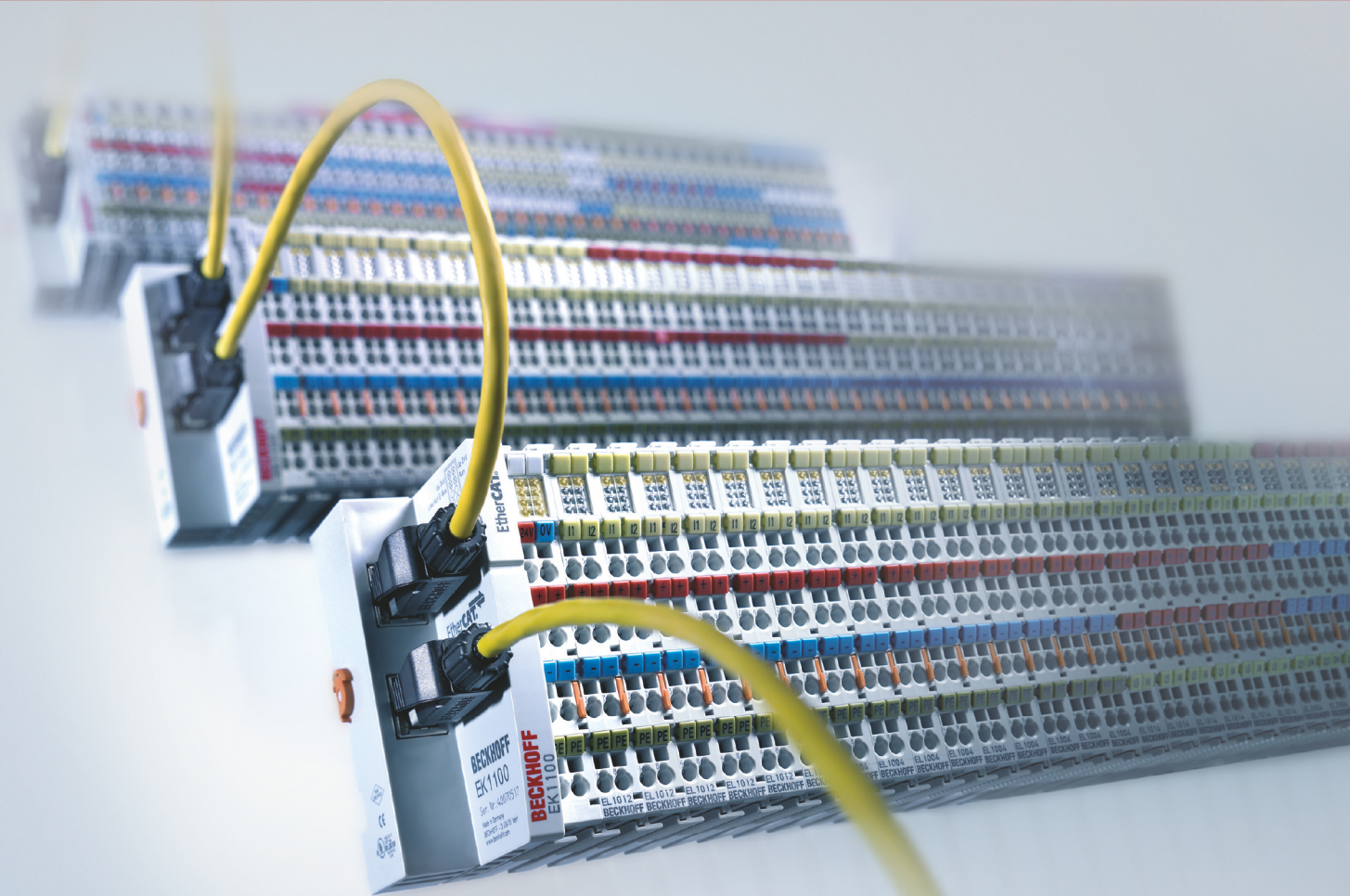



# Table of contents

<b>1</b>	<b>Foreword</b> .....	<b>5</b>
1.1	Overview of EK110x-xxxx and EK15xx EtherCAT couplers .....	5
1.2	Notes on the documentation .....	6
1.3	Safety instructions .....	7
1.4	Guide through documentation .....	8
1.5	Documentation issue status .....	9
1.6	Version identification of EtherCAT devices .....	11
1.6.1	General notes on marking .....	11
1.6.2	Version identification of EK Couplers .....	12
1.6.3	Beckhoff Identification Code (BIC) .....	13
1.6.4	Electronic access to the BIC (eBIC) .....	15
<b>2</b>	<b>Product overview</b> .....	<b>17</b>
2.1	Overview of EtherCAT couplers .....	17
2.2	Coupler with RJ45 connection .....	19
2.2.1	EK1100 .....	19
2.2.2	EK1101 .....	21
2.2.3	EK1101-0010 .....	23
2.2.4	EK1101-0080 .....	27
2.3	Coupler with M8 connection .....	32
2.3.1	EK1100-0008 .....	32
2.3.2	EK1101-0008 .....	34
2.4	Coupler with optical fiber connection .....	36
2.4.1	EK1501 .....	36
2.4.2	EK1501-0010 .....	39
2.5	Coupler with POF connection .....	42
2.5.1	EK1541 .....	42
<b>3</b>	<b>Basics communication</b> .....	<b>44</b>
3.1	EtherCAT basics .....	44
3.2	EtherCAT coupler port allocation .....	44
3.3	EtherCAT State Machine .....	46
3.4	CoE - Interface: notes .....	47
3.5	EKxxxx - Optional Distributed Clocks support .....	47
<b>4</b>	<b>Mounting and wiring</b> .....	<b>50</b>
4.1	Instructions for ESD protection .....	50
4.2	Explosion protection .....	51
4.2.1	ATEX - Special conditions (extended temperature range) .....	51
4.2.2	IECEX - Special conditions .....	52
4.2.3	Continuative documentation for ATEX and IECEX .....	53
4.2.4	cFMus - Special conditions .....	54
4.2.5	Continuative documentation for cFMus .....	55
4.3	UL notice .....	56
4.4	Installation on mounting rails .....	57
4.5	Installation instructions for enhanced mechanical load capacity .....	60

4.6	Installation positions .....	61
4.7	Connection system.....	63
4.8	Wiring .....	65
4.9	EtherCAT cabling – wire-bound .....	67
4.10	M8 Connector Cabling .....	69
4.11	Nut torque for connectors.....	71
4.12	Note - Power supply.....	72
4.13	Power supply, potential groups .....	72
4.14	Positioning of passive Terminals.....	75
4.15	Disposal .....	76
<b>5</b>	<b>Commissioning/application notes.....</b>	<b>77</b>
5.1	Configuration overview.....	77
5.2	Notes for couplers with fiber-optic connection .....	78
5.2.1	Principles of fiber-optic technology .....	79
5.2.2	Notes on suitable optical fiber cables.....	84
5.2.3	Application with EK1501 and EK1501-0010 .....	85
5.3	Notes for couplers with POF connection.....	87
5.3.1	Notes regarding suitable POF cables .....	87
5.3.2	Application with EK1541 .....	87
5.3.3	Notes regarding assembly of POF cables with the connector set ZS1090-0008.....	89
<b>6</b>	<b>Diagnostic LEDs.....</b>	<b>93</b>
6.1	EK1100, EK1100-0008 .....	93
6.2	EK1101-xxxx .....	94
6.3	EK1501, EK1501-0010, EK1541.....	95
<b>7</b>	<b>Appendix.....</b>	<b>96</b>
7.1	Volatility.....	96
7.2	Safety instructions and behavioral rules for Class 1 laser .....	97
7.3	Firmware compatibility .....	98
7.4	Firmware Update EL/ES/EM/ELM/EPxxxx.....	99
7.4.1	Device description ESI file/XML .....	100
7.4.2	Firmware explanation.....	103
7.4.3	Updating controller firmware *.efw .....	104
7.4.4	FPGA firmware *.rbf.....	106
7.4.5	Simultaneous updating of several EtherCAT devices.....	110
7.5	Support and Service.....	111

# 1 Foreword

## 1.1 Overview of EK110x-xxxx and EK15xx EtherCAT couplers

### Connection RJ45

[EK1100 \[▶ 19\]](#) - EtherCAT Bus Coupler

[EK1101 \[▶ 21\]](#) - EtherCAT Bus Coupler with ID switch, Hot-Connect

[EK1101-0010 \[▶ 23\]](#) - EtherCAT Bus Coupler with ID switch, Extended Distance

[EK1101-0080 \[▶ 27\]](#) - EtherCAT Bus Coupler with ID switch, Fast-Hot-Connect

### Connection M8

[EK1100-0008 \[▶ 32\]](#) - EtherCAT Bus Coupler

[EK1101-0008 \[▶ 34\]](#) - EtherCAT Bus Coupler with ID switch

### Connection Fiber optic

[EK1501 \[▶ 36\]](#) - EtherCAT Bus Coupler with ID switch (Fiber Optic, Multimode)

[EK1501-0010 \[▶ 39\]](#) - EtherCAT Bus Coupler with ID switch (Fiber Optic, Singlemode)

### Connection Polymeric Optical Fiber

[EK1541 \[▶ 42\]](#) - EtherCAT Bus Coupler with ID switch (Polymeric Optical Fiber)

## 1.2 Notes on the documentation

### Intended audience

This description is only intended for the use of trained specialists in control and automation engineering who are familiar with the applicable national standards.

It is essential that the documentation and the following notes and explanations are followed when installing and commissioning these components.

The qualified personnel is obliged to always use the currently valid documentation.

The responsible staff must ensure that the application or use of the products described satisfy all the requirements for safety, including all the relevant laws, regulations, guidelines and standards.

### Disclaimer

The documentation has been prepared with care. The products described are, however, constantly under development.

We reserve the right to revise and change the documentation at any time and without prior announcement.

No claims for the modification of products that have already been supplied may be made on the basis of the data, diagrams and descriptions in this documentation.

### Trademarks

Beckhoff®, TwinCAT®, TwinCAT/BSD®, TC/BSD®, EtherCAT®, EtherCAT G®, EtherCAT G10®, EtherCAT P®, Safety over EtherCAT®, TwinSAFE®, XFC®, XTS® and XPlanar® are registered trademarks of and licensed by Beckhoff Automation GmbH. Other designations used in this publication may be trademarks whose use by third parties for their own purposes could violate the rights of the owners.

### Patent Pending

The EtherCAT Technology is covered, including but not limited to the following patent applications and patents: EP1590927, EP1789857, EP1456722, EP2137893, DE102015105702 with corresponding applications or registrations in various other countries.



EtherCAT® is registered trademark and patented technology, licensed by Beckhoff Automation GmbH, Germany.

### Copyright

© Beckhoff Automation GmbH & Co. KG, Germany.

The reproduction, distribution and utilization of this document as well as the communication of its contents to others without express authorization are prohibited.

Offenders will be held liable for the payment of damages. All rights reserved in the event of the grant of a patent, utility model or design.

## 1.3 Safety instructions

### Safety regulations

Please note the following safety instructions and explanations!  
Product-specific safety instructions can be found on following pages or in the areas mounting, wiring, commissioning etc.

### Exclusion of liability

All the components are supplied in particular hardware and software configurations appropriate for the application. Modifications to hardware or software configurations other than those described in the documentation are not permitted, and nullify the liability of Beckhoff Automation GmbH & Co. KG.

### Personnel qualification

This description is only intended for trained specialists in control, automation and drive engineering who are familiar with the applicable national standards.

### Signal words

The signal words used in the documentation are classified below. In order to prevent injury and damage to persons and property, read and follow the safety and warning notices.

#### Personal injury warnings

**⚠ DANGER**

Hazard with high risk of death or serious injury.

**⚠ WARNING**

Hazard with medium risk of death or serious injury.

**⚠ CAUTION**

There is a low-risk hazard that could result in medium or minor injury.

#### Warning of damage to property or environment

**NOTICE**

The environment, equipment, or data may be damaged.

#### Information on handling the product



This information includes, for example:  
recommendations for action, assistance or further information on the product.

## 1.4 Guide through documentation

### NOTICE



#### Further components of documentation

This documentation describes device-specific content. It is part of the modular documentation concept for Beckhoff I/O components. For the use and safe operation of the device / devices described in this documentation, additional cross-product descriptions are required, which can be found in the following table.

Title	Description
<b>EtherCAT System Documentation</b> ( <a href="#">PDF</a> )	<ul style="list-style-type: none"> <li>• System overview</li> <li>• EtherCAT basics</li> <li>• Cable redundancy</li> <li>• Hot Connect</li> <li>• EtherCAT devices configuration</li> </ul>
<b>Explosion Protection for Terminal Systems</b> ( <a href="#">PDF</a> )	Notes on the use of the Beckhoff terminal systems in hazardous areas according to ATEX and IECEx
<b>Control Drawing I/O, CX, CPX</b> ( <a href="#">PDF</a> )	Connection diagrams and Ex markings (conform to cFMus)
<b>EtherCAT Terminals in the Marine Sector</b> ( <a href="#">PDF</a> )	Notes for operation of the Beckhoff EtherCAT Terminal System in the Marine Sector (DNV GL)
<b>Infrastructure for EtherCAT/Ethernet</b> ( <a href="#">PDF</a> )	Technical recommendations and notes for design, implementation and testing
<b>Software Declarations I/O</b> ( <a href="#">PDF</a> )	Open source software declarations for Beckhoff I/O components

The documentations can be viewed at and downloaded from the Beckhoff website ([www.beckhoff.com](http://www.beckhoff.com)) via:

- the “Documentation and Download” area of the respective product page,
- the [Download finder](#),
- the [Beckhoff Information System](#).



## 1.5 Documentation issue status

from version 3.1	
Version	Modifications
4.4	<ul style="list-style-type: none"> <li>• Update chapter "Technical data"</li> <li>• Structural update</li> </ul>
4.3	<ul style="list-style-type: none"> <li>• Update chapter "Technical data"</li> <li>• Chapter "Note – Power supply" added</li> <li>• Structural update</li> </ul>
4.2	<ul style="list-style-type: none"> <li>• Update chapter „Appendix“</li> <li>• Structural update</li> </ul>
4.1	<ul style="list-style-type: none"> <li>• Update chapter „Version identification of EtherCAT devices“</li> <li>• Update chapter „Overview of EtherCAT couplers“</li> <li>• Update chapter „Technical data“</li> <li>• chapter „cFMus – Special conditions“ and „Continuative documentation for cFMus“ added</li> <li>• Chapter „Disposal“ added</li> <li>• Structural update</li> </ul>
4.0	<ul style="list-style-type: none"> <li>• Update chapter „EtherCAT cabling – wire-bound“</li> <li>• Structural update</li> </ul>
3.9	<ul style="list-style-type: none"> <li>• New Title page</li> <li>• Addenda EK1101-0010</li> <li>• Structural update</li> </ul>
3.8	<ul style="list-style-type: none"> <li>• Ergänzung EK1101-0008</li> <li>• Update Kapitel „Versionsidentifikation von EtherCAT-Geräten“</li> <li>• Update Kapitel „Technische Daten“</li> <li>• Addenda chapter „Principles of fiber-optic technology“</li> <li>• Structural update</li> </ul>
3.7	<ul style="list-style-type: none"> <li>• Structural update</li> <li>• Update chapter „Technical data“</li> </ul>
3.6	<ul style="list-style-type: none"> <li>• Structural update</li> <li>• Update chapter „Technical data“</li> <li>• Update chapter „Firmware Update EL/ES/EM/EPxxxx“</li> </ul>
3.5	<ul style="list-style-type: none"> <li>• Correction of LED description</li> <li>• Structural update</li> </ul>
3.4	<ul style="list-style-type: none"> <li>• Update chapter „Mounting and wiring“</li> </ul>
3.3	<ul style="list-style-type: none"> <li>• Update chapter „Technical data“</li> </ul>
3.2	<ul style="list-style-type: none"> <li>• Update chapter „Notes on documentation“</li> <li>• Update chapter „Technical data“</li> <li>• Notes on ESD protection added</li> <li>• Chapter „ATEX – special conditions“ replaced by chapter „ATEX – special conditions (extended temperature range)“</li> <li>• Chapter „ATEX - Documentation“ inserted</li> </ul>
3.1	<ul style="list-style-type: none"> <li>• Update chapter „Introduction“</li> <li>• Structural update</li> </ul>

until version 3.1	
Version	Modifications
3.0	<ul style="list-style-type: none"> <li>• Migration</li> <li>• Addenda of EK1100-0008 (EtherCAT coupler, with M8 sockets)</li> <li>• Chapter „EtherCATwiring – hard-wired“ moved from „Commissioning/application notes“ to „Mounting and wiring“</li> </ul>
2.3	<ul style="list-style-type: none"> <li>• Update chapter „Technical data“</li> <li>• Addenda chapter "Installation instructions for enhanced mechanical load capacity"</li> </ul>
2.2	<ul style="list-style-type: none"> <li>• Update chapter „Technical data“</li> <li>• Update chapter „Supply, Potential Groups“</li> </ul>
2.1	<ul style="list-style-type: none"> <li>• Update Technical data</li> </ul>
2.0	<ul style="list-style-type: none"> <li>• Structural update</li> </ul>
1.9	<ul style="list-style-type: none"> <li>• Update connection diagram</li> </ul>
1.8	<ul style="list-style-type: none"> <li>• Addition EK1101-0080</li> </ul>
1.7	<ul style="list-style-type: none"> <li>• Update Power Supply, Potential Groups</li> <li>• Notes re. POF coupler added</li> </ul>
1.6	<ul style="list-style-type: none"> <li>• Addition EK1541</li> </ul>
1.5	<ul style="list-style-type: none"> <li>• Addition DC support</li> </ul>
1.4	<ul style="list-style-type: none"> <li>• GND concept added</li> </ul>
1.3	<ul style="list-style-type: none"> <li>• EK1101, EK1501, EK1501-0010 added</li> </ul>
1.2	<ul style="list-style-type: none"> <li>• New safety instructions added, corrections</li> </ul>
1.1	<ul style="list-style-type: none"> <li>• Port assignment added</li> </ul>
1.0	<ul style="list-style-type: none"> <li>• Technical data added</li> </ul>
0.2	<ul style="list-style-type: none"> <li>• Minor corrections</li> </ul>
0.1	<ul style="list-style-type: none"> <li>• First preliminary version</li> </ul>

## 1.6 Version identification of EtherCAT devices

### 1.6.1 General notes on marking

#### Designation

A Beckhoff EtherCAT device has a 14-digit designation, made up of

- family key
- type
- version
- revision

Example	Family	Type	Version	Revision
EL3314-0000-0016	EL terminal 12 mm, non-pluggable connection level	3314 4-channel thermocouple terminal	0000 basic type	0016
ES3602-0010-0017	ES terminal 12 mm, pluggable connection level	3602 2-channel voltage measurement	0010 high-precision version	0017
CU2008-0000-0000	CU device	2008 8-port fast ethernet switch	0000 basic type	0000

#### Notes

- The elements mentioned above result in the **technical designation**. EL3314-0000-0016 is used in the example below.
- EL3314-0000 is the order identifier, in the case of “-0000” usually abbreviated to EL3314. “-0016” is the EtherCAT revision.
- The **order identifier** is made up of
  - family key (EL, EP, CU, ES, KL, CX, etc.)
  - type (3314)
  - version (-0000)
- The **revision** -0016 shows the technical progress, such as the extension of features with regard to the EtherCAT communication, and is managed by Beckhoff.  
 In principle, a device with a higher revision can replace a device with a lower revision, unless specified otherwise, e.g. in the documentation.  
 Associated and synonymous with each revision there is usually a description (ESI, EtherCAT Slave Information) in the form of an XML file, which is available for download from the Beckhoff web site.  
 From 2014/01 the revision is shown on the outside of the IP20 terminals, see Fig. “EL5021 EL terminal, standard IP20 IO device with batch number and revision ID (since 2014/01)”.
- The type, version and revision are read as decimal numbers, even if they are technically saved in hexadecimal.

## 1.6.2 Version identification of EK Couplers

The serial number/ data code for Beckhoff IO devices is usually the 8-digit number printed on the device or on a sticker. The serial number indicates the configuration in delivery state and therefore refers to a whole production batch, without distinguishing the individual modules of a batch.

Structure of the serial number: **KK YY FF HH**

KK - week of production (CW, calendar week)

YY - year of production

FF - firmware version

HH - hardware version

Example with serial number 12 06 3A 02:

12 - production week 12

06 - production year 2006

3A - firmware version 3A

02 - hardware version 02



Fig. 1: EK1101 EtherCAT coupler with revision 0815 and serial number 41130206

### 1.6.3 Beckhoff Identification Code (BIC)

The Beckhoff Identification Code (BIC) is increasingly being applied to Beckhoff products to uniquely identify the product. The BIC is represented as a Data Matrix Code (DMC, code scheme ECC200), the content is based on the ANSI standard MH10.8.2-2016.

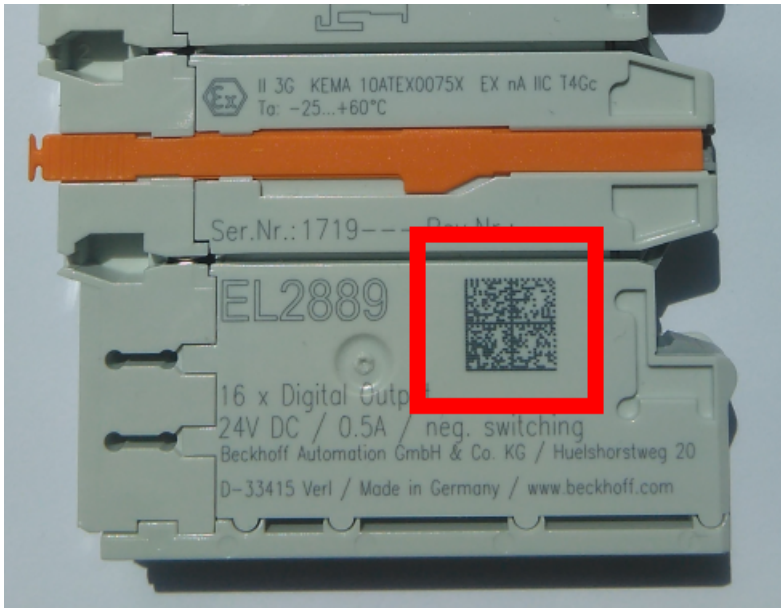

Fig. 2: BIC as data matrix code (DMC, code scheme ECC200)

The BIC will be introduced step by step across all product groups.

Depending on the product, it can be found in the following places:

- on the packaging unit
- directly on the product (if space suffices)
- on the packaging unit and the product

The BIC is machine-readable and contains information that can also be used by the customer for handling and product management.

Each piece of information can be uniquely identified using the so-called data identifier (ANSI MH10.8.2-2016). The data identifier is followed by a character string. Both together have a maximum length according to the table below. If the information is shorter, spaces are added to it.

Following information is possible, positions 1 to 4 are always present, the other according to need of production:

Position	Type of information	Explanation	Data identifier	Number of digits incl. data identifier	Example
1	Beckhoff order number	<b>Beckhoff order number</b>	1P	8	<b>1P</b> 072222
2	Beckhoff Traceability Number (BTN)	<b>Unique serial number, see note below</b>	SBTN	12	<b>S</b> BTNk4p562d7
3	Article description	<b>Beckhoff article description, e.g. EL1008</b>	1K	32	<b>1K</b> EL1809
4	Quantity	<b>Quantity in packaging unit, e.g. 1, 10, etc.</b>	Q	6	<b>Q</b> 1
5	Batch number	Optional: Year and week of production	2P	14	<b>2P</b> 401503180016
6	ID/serial number	Optional: Present-day serial number system, e.g. with safety products	51S	12	<b>51S</b> 678294
7	Variant number	Optional: Product variant number on the basis of standard products	30P	32	<b>30P</b> F971, 2*K183
...					

Further types of information and data identifiers are used by Beckhoff and serve internal processes.

### Structure of the BIC

Example of composite information from positions 1 to 4 and with the above given example value on position 6. The data identifiers are highlighted in bold font:

**1P**072222**S**BTNk4p562d7**1K**EL1809 **Q**1 **51S**678294

Accordingly as DMC:



Fig. 3: Example DMC **1P**072222**S**BTNk4p562d7**1K**EL1809 **Q**1 **51S**678294

### BTN

An important component of the BIC is the Beckhoff Traceability Number (BTN, position 2). The BTN is a unique serial number consisting of eight characters that will replace all other serial number systems at Beckhoff in the long term (e.g. batch designations on IO components, previous serial number range for safety products, etc.). The BTN will also be introduced step by step, so it may happen that the BTN is not yet coded in the BIC.

### NOTICE

This information has been carefully prepared. However, the procedure described is constantly being further developed. We reserve the right to revise and change procedures and documentation at any time and without prior notice. No claims for changes can be made from the information, illustrations and descriptions in this information.

## 1.6.4 Electronic access to the BIC (eBIC)

### Electronic BIC (eBIC)

The Beckhoff Identification Code (BIC) is applied to the outside of Beckhoff products in a visible place. If possible, it should also be electronically readable.

Decisive for the electronic readout is the interface via which the product can be electronically addressed.

### K-bus devices (IP20, IP67)

Currently, no electronic storage and readout is planned for these devices.

### EtherCAT devices (IP20, IP67)

All Beckhoff EtherCAT devices have a so-called ESI-EEPROM, which contains the EtherCAT identity with the revision number. Stored in it is the EtherCAT slave information, also colloquially known as ESI/XML configuration file for the EtherCAT master. See the corresponding chapter in the EtherCAT system manual ([Link](#)) for the relationships.

The eBIC is also stored in the ESI-EEPROM. The eBIC was introduced into the Beckhoff I/O production (terminals, box modules) from 2020; widespread implementation is expected in 2021.

The user can electronically access the eBIC (if existent) as follows:

- With all EtherCAT devices, the EtherCAT master (TwinCAT) can read the eBIC from the ESI-EEPROM
  - From TwinCAT 3.1 build 4024.11, the eBIC can be displayed in the online view.
  - To do this, check the checkbox "Show Beckhoff Identification Code (BIC)" under EtherCAT → Advanced Settings → Diagnostics:

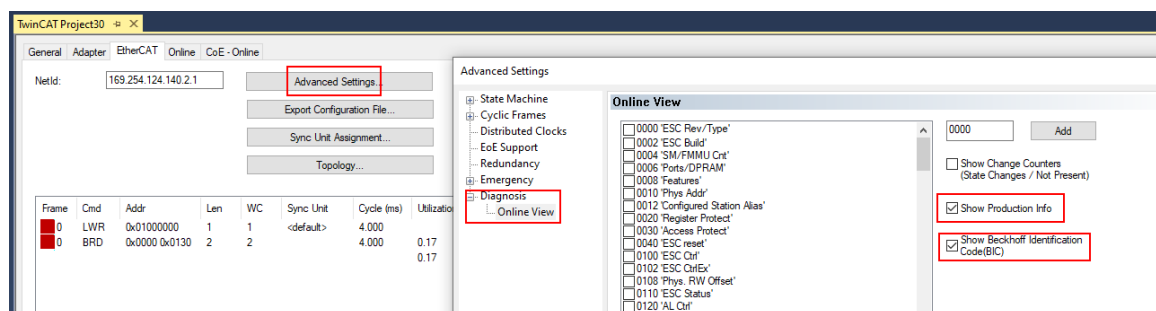

- The BTN and its contents are then displayed:

No	Addr	Name	State	CRC	Fw	Hw	Production Data	ItemNo	BTN	Description	Quantity	BatchNo	SerialNo
1	1001	Term 1 (EK1100)	OP	0,0	0	0	---						
2	1002	Term 2 (EL1018)	OP	0,0	0	0	2020 KW36 Fr	072222	k4p562d7	EL1809	1		678294
3	1003	Term 3 (EL3204)	OP	0,0	7	6	2012 KW24 Sa						
4	1004	Term 4 (EL2004)	OP	0,0	0	0	---	072223	k4p562d7	EL2004	1		678295
5	1005	Term 5 (EL1008)	OP	0,0	0	0	---						
6	1006	Term 6 (EL2008)	OP	0,0	0	12	2014 KW14 Mo						
7	1007	Term 7 (EK1110)	OP	0	1	8	2012 KW25 Mo						

- Note: as can be seen in the illustration, the production data HW version, FW version and production date, which have been programmed since 2012, can also be displayed with "Show Production Info".
- Access from the PLC: From TwinCAT 3.1. build 4024.24 the functions *FB\_EcReadBIC* and *FB\_EcReadBTN* are available in the Tc2\_EtherCAT Library from v3.3.19.0 for reading into the PLC..
- In the case of EtherCAT devices with CoE directory, the object 0x10E2:01 can additionally be used to display the device's own eBIC; the PLC can also simply access the information here:

- The device must be in PREOP/SAFEOP/OP for access:

Index	Name	Flags	Value
1000	Device type	RO	0x015E1389 (22942601)
1008	Device name	RO	ELM3704-0000
1009	Hardware version	RO	00
100A	Software version	RO	01
100B	Bootloader version	RO	J0.1.27.0
1011:0	Restore default parameters	RO	> 1 <
1018:0	Identity	RO	> 4 <
10E2:0	Manufacturer-specific Identification C...	RO	> 1 <
10E2:01	SubIndex 001	RO	1P158442SBTN0008jekp1KELM3704 Q1 2P482001000016
10F0:0	Backup parameter handling	RO	> 1 <
10F3:0	Diagnosis History	RO	> 21 <
10F8	Actual Time Stamp	RO	0x170bfb277e

- The object 0x10E2 will be introduced into stock products in the course of a necessary firmware revision.
- From TwinCAT 3.1. build 4024.24 the functions *FB\_EcCoEReadBIC* and *FB\_EcCoEReadBTN* are available in the *Tc2\_EtherCAT Library* from v3.3.19.0 for reading into the PLC.
- For processing the BIC/BTN data in the PLC, the following auxiliary functions are available in *Tc2\_Uilities* from TwinCAT 3.1 build 4024.24 onwards
  - *F\_SplitBIC*: The function splits the Beckhoff Identification Code (BIC) *sBICValue* into its components based on known identifiers and returns the recognized partial strings in a structure *ST\_SplitBIC* as return value.
  - *BIC\_TO\_BTN*: The function extracts the BTN from the BIC and returns it as a value.
- Note: in the case of electronic further processing, the BTN is to be handled as a string(8); the identifier "SBTN" is not part of the BTN.
- Technical background
 

The new BIC information is additionally written as a category in the ESI-EEPROM during the device production. The structure of the ESI content is largely dictated by the ETG specifications, therefore the additional vendor-specific content is stored with the help of a category according to ETG.2010. ID 03 indicates to all EtherCAT masters that they must not overwrite these data in case of an update or restore the data after an ESI update.

The structure follows the content of the BIC, see there. This results in a memory requirement of approx. 50..200 bytes in the EEPROM.
- Special cases
  - If multiple, hierarchically arranged ESCs are installed in a device, only the top-level ESC carries the eBIC Information.
  - If multiple, non-hierarchically arranged ESCs are installed in a device, all ESCs carry the eBIC Information.
  - If the device consists of several sub-devices with their own identity, but only the top-level device is accessible via EtherCAT, the eBIC of the top-level device is located in the CoE object directory 0x10E2:01 and the eBICs of the sub-devices follow in 0x10E2:nn.

### PROFIBUS, PROFINET, DeviceNet devices etc.

Currently, no electronic storage and readout is planned for these devices.



## 2 Product overview

### 2.1 Overview of EtherCAT couplers

An EtherCAT coupler is required in order to connect EtherCAT Terminals with E-bus-communication (series ELxxxx, ESxxxx, EMxxxx) to an EtherCAT network. This coupler relays the communication from the higher-level EtherCAT network to the terminals, or functions as a master itself and generates telegrams. Beckhoff offers different components for different application scenarios.

The selection of the correct coupler depends on the following criteria:

- is a local small controller needed?
- is the coupler to be connected via copper cable or optical fiber cable?
- is the coupler to be addressed via IP or is it located in the unswitched network?
- is the coupler to be controlled via EAP (EtherCAT Automation Protocol) or EtherCAT Device Protocol?
- required protection class: IP20 or higher?
- is the coupler to be plugged in at different places at the network using the HotConnect technique?

A coupler connects the added terminals to the right; it can be connected to the higher level network to the left. Couplers that support the EtherCAT Device Protocol 'to the left' must be connected there to an EtherCAT master.

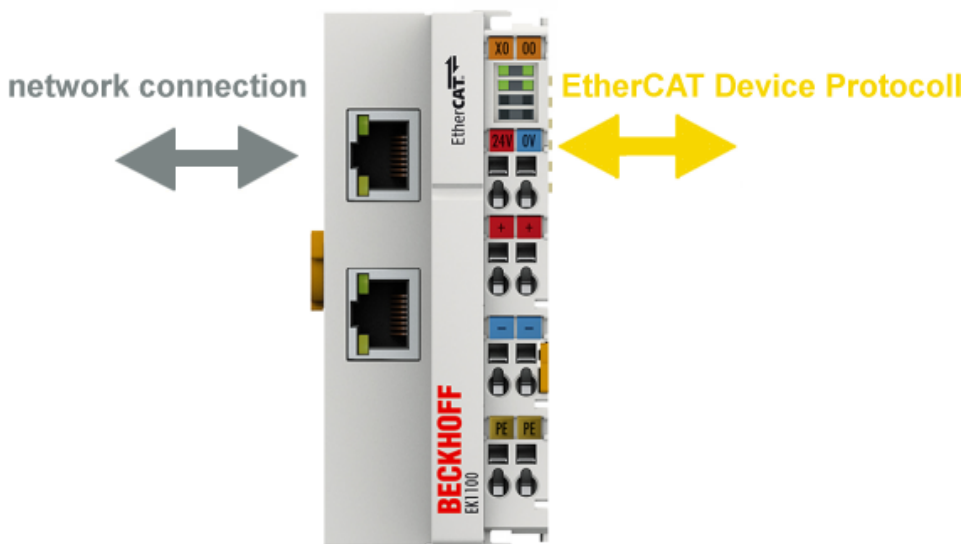

Fig. 4: EtherCAT coupler communication diagram

The following features overview can be used for selection (Beckhoff EtherCAT couplers):

Characteristic	EK1100 EK1100-0008	EK1101 EK1101-0008 EK1101-0010 EK1101-0080	EK1300	EK1501 EK1501-0010	EK1541
Protection class	IP20	IP20	IP20	IP20	IP20
Higher level network technology	100 MBit FastEthernet (100BASE-TX)	100 MBit FastEthernet (100BASE-TX)	100 MBit FastEthernet (100BASE-TX)	100 MBit FastEthernet (100BASE-FX)	100 MBit FastEthernet (100BASE-FX) POF
Higher level network - max. connection length	100 m	100 m EK1101-0010: 300 m between two Extended Distance Couplers	100 m	EK1501: 2 km EK1501-0010: 20 km	50 m
Higher level network connection technology	RJ45 EK1100-0008: M8	RJ45 EK1101-0008: M8	2 x M8 socket, shielded, screw type, EtherCAT-P-code	SC duplex EK1501: Multi-mode optical fiber cable EK1501-0010: Single-mode optical fiber cable	Versatile Link POF duplex connector Polymeric Optical Fiber
higher-level network protocol	EtherCAT Device Protocol (formerly Direct Mode)	EtherCAT Device Protocol (formerly Direct Mode)	EtherCAT Device Protocol (to 100BASE-TX EtherCAT P networks)	EtherCAT Device Protocol (formerly Direct Mode)	EtherCAT Device Protocol (formerly Direct Mode)
integrated PLC	-	-	-	-	-
supports HotConnect with address setting on the device	-	yes EK1101-0080: Fast-Hot-Connect ▶ 29]	-	yes	yes
Note	The EK1100 is the "standard" coupler for use directly on the EtherCAT master.	EK1101-0010: Distance between stations: max. 300 m (copper, Cat. 5, 4-wire).	Coupling of EtherCAT Terminals (ELxxxx) to 100BASE-TX EtherCAT P networks		

Characteristic	EK18xx	EK9000	EKx000	EPxxxx	CX8000
Protection class	IP20	IP20	IP20	IP67	IP20
Higher level network technology	100 MBit FastEthernet (100BASE-TX)	100 MBit FastEthernet (100BASE-TX)	diverse see doc.	100 MBit FastEthernet (100BASE-TX)	100 MBit FastEthernet (100BASE-TX)
Higher level network - max. connection length	100 m	100 m	see doc.	100 m	100 m
Higher level network connection technology	RJ45	RJ45	see doc.	M8	RJ45
higher-level network protocol	EtherCAT Device Protocol (formerly Direct Mode)	EAP	see doc.	EtherCAT Device Protocol (formerly Direct Mode)	EtherCAT Device Protocol (formerly Direct Mode)
integrated PLC	-	-	-	-	yes
supports HotConnect with address setting on the device	-	-	-	-	-
Note	The EK18xx devices integrate a coupler for application directly at the EtherCAT master and digital inputs and outputs without additional wiring.	The EK9000 can be controlled in a switched EtherCAT network with directed IP addressing.	If the EK9000 is provided with another fieldbus connection, this gives rise to the appropriate EKx000 coupler.	Technologically, each EP Box represents a self-contained EtherCAT coupler with internally added I/O functions.	The CX8000 appears to the higher level EtherCAT network as an EtherCAT slave while at the same time managing its attached I/Os as a master.

## 2.2 Coupler with RJ45 connection

### 2.2.1 EK1100

#### 2.2.1.1 Introduction

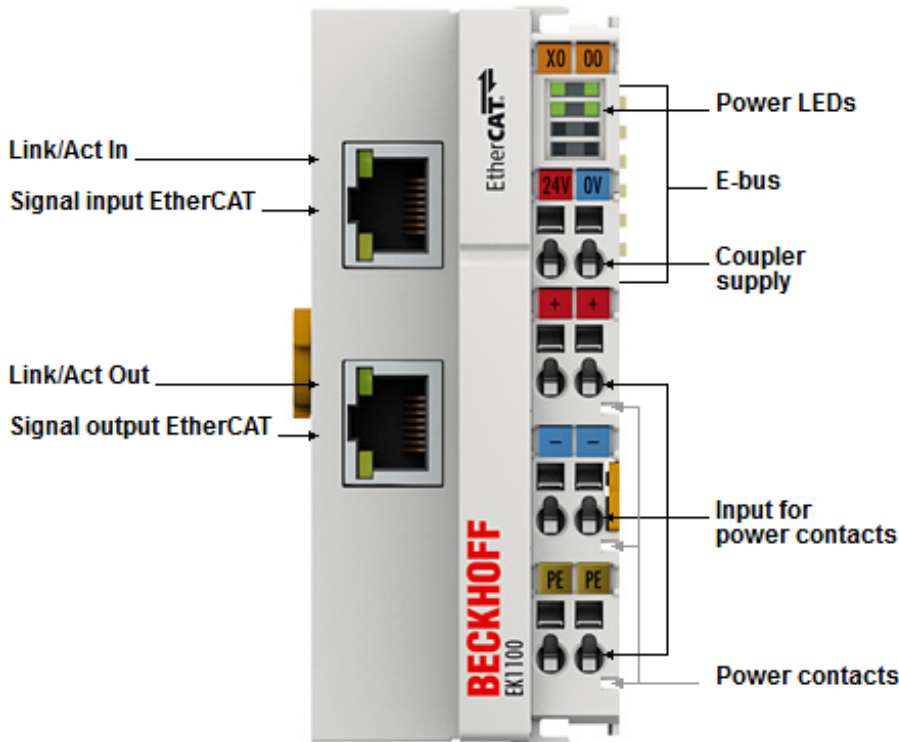

Fig. 5: EK1100

#### EK1100 EtherCAT coupler

The EK1100 coupler connects the EtherCAT Device Protocol with the EtherCAT Terminals (ELxxxx/ESxxxx/EMxxxx). One station consists of a coupler, any number of EtherCAT Terminals and a bus end terminal, e.g. EL9011.

The coupler converts the telegrams from Ethernet 100BASE-TX to E-bus signal representation in passing with minimum latency. The coupler is connected to the network via the upper Ethernet interface. The lower RJ-45 socket may be used to connect further EtherCAT devices in the same strand.

The coupler supplies the connected terminals with the necessary E-bus current for communication. The coupler can supply a maximum of 5 V/2 A. Power feed terminals (e.g. EL9410) must be integrated if more current is required.

In the EtherCAT network, the coupler can be installed anywhere in the Ethernet signal transfer section (100BASE-TX). The coupler thereby processes exclusively unaddressed MAC Broadcast telegrams of the type EtherCAT Device Protocol from the EtherCAT master. Since directed addressing via MAC Unicast or IP addressing is not used, neither a switch nor a router can be used.

The EK9000 / EK1000 coupler is suitable for use on the switch.

#### Quick links

- [EtherCAT basics \[► 44\]](#)
- [Configuration instructions](#)
- [Diagnostic LEDs \[► 93\]](#)

### 2.2.1.2 Technical data

Technical data	EK1100
Task in the EtherCAT system	Coupling of EtherCAT Terminals (ELxxxx) to 100BASE-TX EtherCAT networks
Number of EtherCAT Terminals	up to 65535 in the overall system
Number of peripheral signals	max. 4.2 GB addressable IO points
Data transfer medium	Ethernet 100BASE-TX (at least Ethernet CAT5 cable)
Cable length between 2 Bus Couplers	max. 100 m (100BASE-TX)
Protocol / Baud rate	EtherCAT Device Protocol / 100 Mbaud
HotConnect	no
Delay	1 µs typ.
Bus connection	2 x RJ45
Power supply	24 V <sub>DC</sub> (-15%/+20%)
Current consumption	70 mA + (∑ E-bus current/4)
E-bus power supply (5 V)	max. 2 A (-25 °C ... +55 °C)
(at higher current consumption the <a href="#">EL9410</a> power feed terminal can be used in addition)	max. 1 A (> +55 °C)
Power contacts	max. 24 V <sub>DC</sub> , max. 10 A
Electrical isolation	500 V (power contact/supply voltage/EtherCAT)
Dimensions (W x H x D)	approx. 44 mm x 100 mm x 68 mm
Weight	approx. 105 g
Permissible ambient temperature range during operation	-25°C ... +60°C (extended temperature range)
Permissible ambient temperature range during storage	-40°C ... + 85°C
Permissible relative air humidity	95%, no condensation
<a href="#">Mounting</a> [ <a href="#">▶ 50</a> ]	on 35 mm mounting rail according to EN 60715
Vibration / shock resistance	conforms to EN 60068-2-6 / EN 60068-2-27, see also <a href="#">Installation instructions</a> [ <a href="#">▶ 60</a> ] for enhanced mechanical load capacity
EMC immunity / emission	conforms to EN 61000-6-2 / EN 61000-6-4
Protection class	IP20
Installation position	variable
Approvals / markings	CE, EAC, UKCA <a href="#">ATEX</a> [ <a href="#">▶ 51</a> ], <a href="#">IECEX</a> [ <a href="#">▶ 52</a> ], <a href="#">cFMus</a> [ <a href="#">▶ 54</a> ] <a href="#">cULus</a> [ <a href="#">▶ 56</a> ], GL

#### Ex markings

Standard	Marking
ATEX	II 3 G Ex nA IIC T4 Gc II 3 D Ex tc IIIC T135 °C Dc
IECEX	Ex nA IIC T4 Gc Ex tc IIIC T135 °C Dc
cFMus	Class I, Division 2, Groups A, B, C, D Class I, Zone 2, AEx/Ex ec IIC T4 Gc

\*) Real applicable approvals/markings see type plate on the side (product marking).

## 2.2.2 EK1101

### 2.2.2.1 Introduction

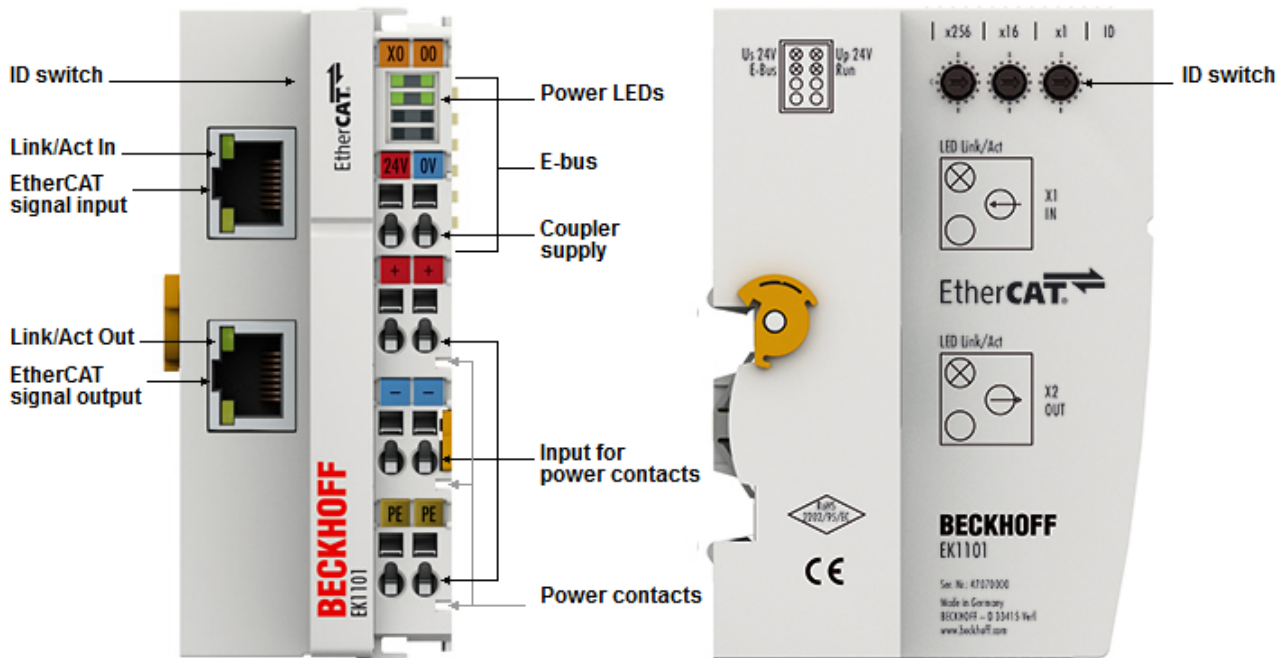

Fig. 6: EK1101

#### EK1101 EtherCAT coupler with ID switch

The EK1101 coupler connects the EtherCAT Device Protocol with the EtherCAT Terminals (ELxxxx/ESxxxx/EMxxxx). One station consists of a coupler, any number of EtherCAT Terminals and a bus end terminal, e.g. EL9011.

The coupler converts the telegrams from Ethernet 100BASE-TX to E-bus signal representation in passing with minimum latency. The coupler is connected to the network via the upper Ethernet interface. The lower RJ-45 socket may be used to connect further EtherCAT devices in the same strand.

The coupler supplies the connected terminals with the necessary E-bus current for communication. The coupler can supply a maximum of 5 V/2 A. Power feed terminals (e.g. EL9410) must be integrated if more current is required.

In the EtherCAT network, the coupler can be installed anywhere in the Ethernet signal transfer section (100BASE-TX). The coupler thereby processes exclusively unaddressed MAC Broadcast telegrams of the type EtherCAT Device Protocol from the EtherCAT master. Since directed addressing via MAC Unicast or IP addressing is not used, neither a switch nor a router can be used.

The EK1101 supports the HotConnect procedure, see [EtherCAT](#) documentation. The characteristics of the EK1101 in relation to this are:

- the ID can be set on the device via three rotary selection switches within the range 0..4095 (hexadecimal)
- the ID is readable online by the EtherCAT master via the process data
- if the EtherCAT master supports HotConnect, then an I/O group can be adopted dynamically into the EtherCAT communication. This group can then be located at any position within the EtherCAT network. Variable topologies are therefore easily implementable.

#### Quick links

- [EtherCAT basics](#) [▶ 44]
- [Configuration instructions](#)
- [Diagnostic LEDs](#) [▶ 94]

### 2.2.2.2 Technical data

Technical data	EK1101
Task in the EtherCAT system	Coupling of EtherCAT Terminals (ELxxxx) to 100BASE-TX EtherCAT networks
Number of EtherCAT Terminals	up to 65535 in the overall system
Number of peripheral signals	max. 4.2 GB addressable IO points
Data transfer medium	Ethernet 100BASE-TX (at least Ethernet CAT5 cable)
Cable length between 2 Bus Couplers	max. 100 m (100BASE-TX)
Protocol / Baud rate	EtherCAT Device Protocol / 100 MBaud
HotConnect	max. number of configurable IDs: 4096
Delay	1 µs typ.
Bus connection	2 x RJ45
Power supply	24 V <sub>DC</sub> (-15%/+20%)
Current consumption	70 mA + (∑ E-bus current)/4
E-bus power supply (5 V) dependent on the ambient temperature (at higher current consumption the <a href="#">EL9410</a> power feed terminal can be used in addition)	max. 2 A (-25 °C ... +55 °C) max. 1 A (> +55 °C)
Power contacts	max. 24 V <sub>DC</sub> , max. 10 A
Electrical isolation	500 V (power contact/supply voltage/EtherCAT)
Dimensions (W x H x D)	approx. 44 mm x 100 mm x 68 mm
Weight	approx. 105 g
Permissible ambient temperature range during operation	-25°C ... +60°C (extended temperature range)
Permissible ambient temperature range during storage	-40°C ... + 85°C
Permissible relative air humidity	95%, no condensation
<a href="#">Mounting</a> [ <a href="#">▶ 50</a> ]	on 35 mm mounting rail according to EN 60715
Vibration / shock resistance	conforms to EN 60068-2-6 / EN 60068-2-27
EMC immunity / emission	conforms to EN 61000-6-2 / EN 61000-6-4
Protection class	IP20
Installation position	variable
Approvals / markings	CE, EAC, UKCA <a href="#">ATEX</a> [ <a href="#">▶ 51</a> ], <a href="#">IECEX</a> [ <a href="#">▶ 52</a> ], <a href="#">cFMus</a> [ <a href="#">▶ 54</a> ] <a href="#">cULus</a> [ <a href="#">▶ 56</a> ], GL

#### Ex markings

Standard	Marking
ATEX	II 3 G Ex nA IIC T4 Gc II 3 D Ex tc IIIC T135 °C Dc
IECEX	Ex nA IIC T4 Gc Ex tc IIIC T135 °C Dc
cFMus	Class I, Division 2, Groups A, B, C, D Class I, Zone 2, AEx/Ex ec IIC T4 Gc

\*) Real applicable approvals/markings see type plate on the side (product marking).

## 2.2.3 EK1101-0010

### 2.2.3.1 Introduction

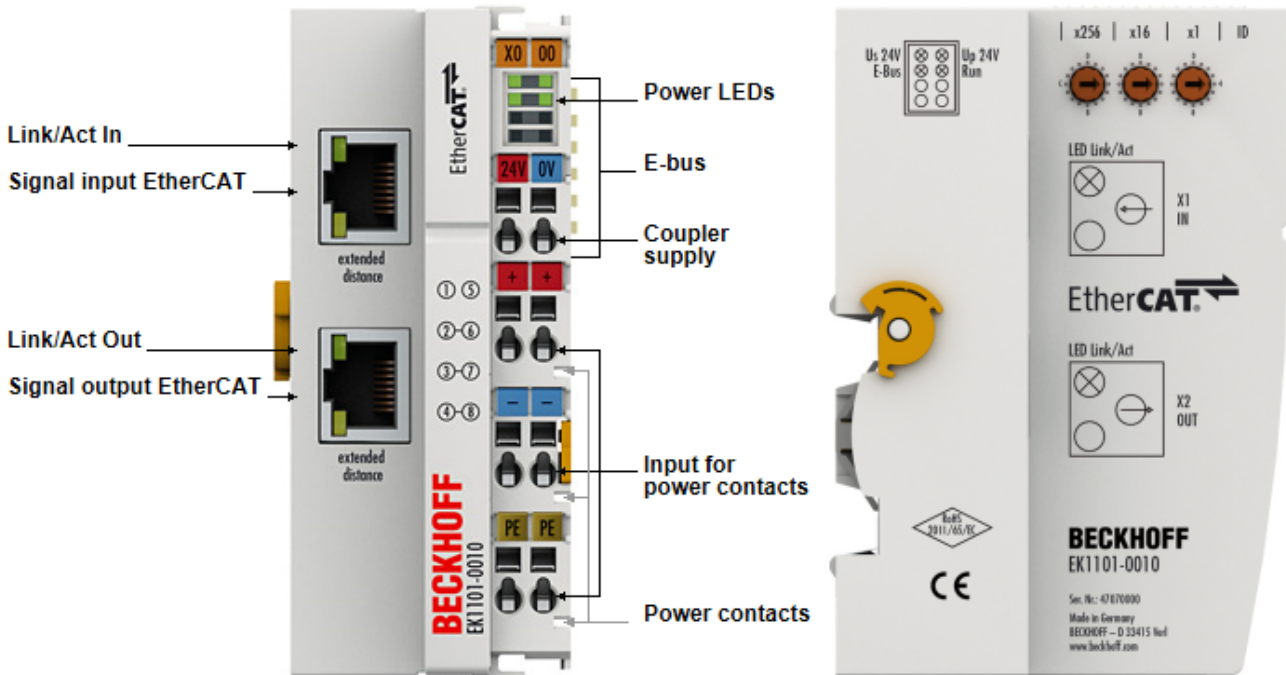

Fig. 7: EK1101-0010

#### EK1101-0010 EtherCAT coupler with ID switch, Extended Distance

The EK1101-0010 coupler connects the EtherCAT Device Protocol with the EtherCAT Terminals (ELxxxx/ESxxxx/EMxxxx). One station consists of an EK1101-0010 coupler, any number of EtherCAT Terminals and a bus end terminal, e.g. EL9011.

The coupler converts the telegrams from Ethernet 100BASE-TX or BroadR to E-bus signal representation in passing with minimum latency. The coupler is connected to the network via the upper Ethernet interface. The lower RJ-45 socket may be used to connect further EtherCAT devices in the same strand.

Using the extended distance connection, distances of up to 300 m can be bridged between two Extended Distance Couplers. If only one connection of the two Couplers is configured for Extended Distance, the maximum distance between the stations is 100 m.

The coupler supplies the connected terminals with the necessary E-bus current for communication. The coupler can supply a maximum of 5 V/2 A. Power feed terminals (e.g. EL9410) must be integrated if more current is required.

In the EtherCAT network, the coupler can be installed anywhere in the Ethernet signal transfer section (100BASE-TX or BroadR). The coupler thereby processes exclusively unaddressed MAC Broadcast telegrams of the type EtherCAT Device Protocol from the EtherCAT master. Since directed addressing via MAC Unicast or IP addressing is not used, neither a switch nor a router can be used.

The EK1101-0010 supports the HotConnect procedure, see [EtherCAT](#) documentation. The characteristics of the EK1101-0010 in relation to this are:

- ID can be set on the device via three rotary selector switches within the range 0 to 4095 (hexadecimal)
- the ID is readable online by the EtherCAT master via the process data
- if the EtherCAT master supports HotConnect, then an I/O group can be adopted dynamically into the EtherCAT communication. This group can then be located at any position within the EtherCAT network. Variable topologies are therefore easily implementable.

## Quick links

- [EtherCAT basics \[► 44\]](#)
- [Configuration instructions](#)
- [Diagnostic LEDs \[► 94\]](#)
- [Notes on extended-distance connection \[► 25\]](#)

## 2.2.3.2 Technical data

Technical data	EK1101-0010
Task within the EtherCAT system	Coupling of EtherCAT Terminals (ELxxxx) to 100BASE-TX or BroadR EtherCAT networks <a href="#">Extended distance connection [► 25]</a>
Number of EtherCAT Terminals	up to 65535 in the overall system
Number of peripheral signals	max. 4.2 GB addressable IO points
Transmission medium	at least Ethernet CAT-5 cable
Cable length between two Bus Couplers	max. 100 m (100BASE-TX) max. 300 m (copper, Cat. 5, 4-wire) between two Extended Distance Couplers
Protocol / Baud rate	EtherCAT Device Protocol / 100 MBaud
HotConnect	max. number of configurable IDs: 4096
Delay	typical 1 µs
Bus connection	2 x RJ45
Power supply	24 V <sub>DC</sub> (-15%/+20%)
Current consumption	90 mA + (Σ E-bus current)/4
E-bus power supply (5 V) depending on ambient temperature (at higher current consumption the <a href="#">EL9410</a> power feed terminal can be used in addition)	max. 2 A (-25°C ... +55°C) max. 1 A (> +55°C)
Power contacts	max. 24 V <sub>DC</sub> , max. 10 A
Electrical isolation	500 V (power contact/supply voltage/EtherCAT)
Dimensions (W x H x D)	approx. 44 mm x 100 mm x 68 mm
Weight	approx. 105 g
Permissible ambient temperature range during operation	0°C ... +55°C
Permissible ambient temperature range during storage	-25°C ... + 85°C
Permissible relative humidity	95%, no condensation
<a href="#">Mounting [► 50]</a>	on 35 mm mounting rail conforms to EN 60715
Vibration/shock resistance	conforms to EN 60068-2-6 / EN 60068-2-27
EMC immunity/emission	conforms to EN 61000-6-2 / EN 61000-6-4
Protection class	IP20
Installation position	variable
Approvals / markings*	CE, EAC, UKCA, <a href="#">cULus [► 56]</a>

\*) Real applicable approvals/markings see type plate on the side (product marking).



### 2.2.3.3 Notes on Extended Distance connection

Using components which support the Extended Distance connection, distances of up to 300 m can be bridged (for connections between two Extended Distance components). These components are marked with “extended distance” both in chapter “Technical data” and on the respective RJ45 sockets of the component. In the TwinCAT System Manager “Extended Distance” is part of the type designation (tab “General”, “Type”).

#### Topologies with Extended Distance components, distances up to 300 m

Distances of up to 300 m can be bridged between two Extended Distance components. Possible topologies are shown in the following figure.

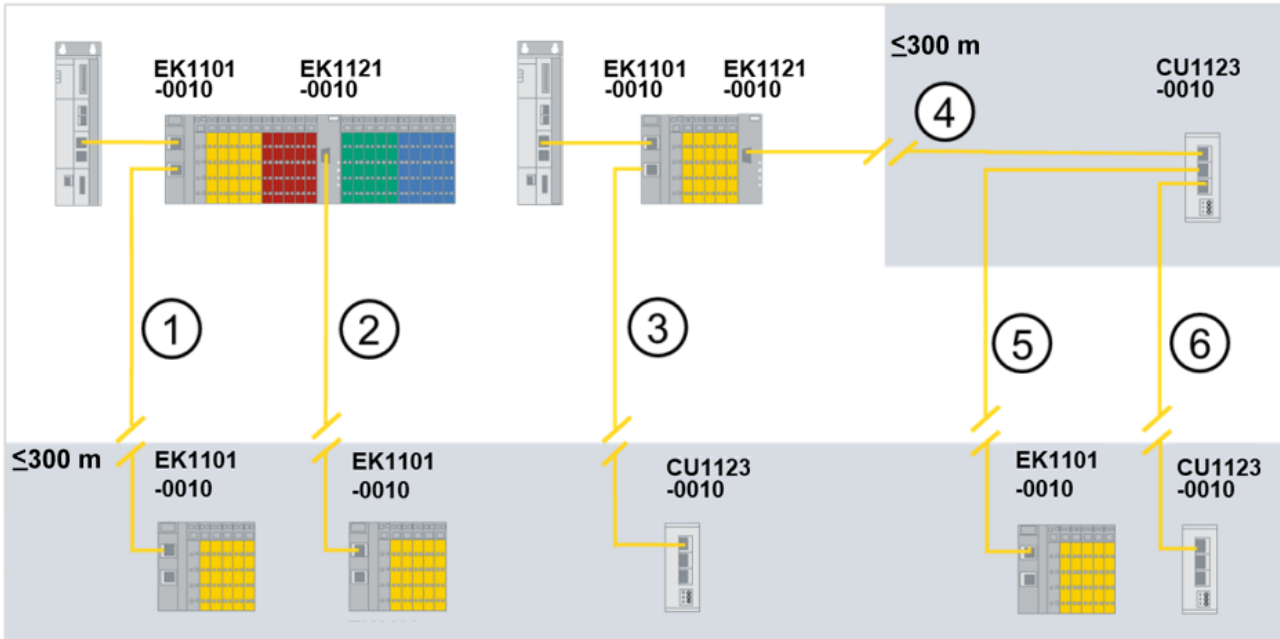

Fig. 8: Topologies with Extended Distance components, distances up to 300 m

Topologies with Extended Distance components, distances up to 300 m		
No. in the figure above	1 <sup>st</sup> Component	2 <sup>nd</sup> Component
1	EK1101-0010	EK1101-0010
2	EK1121-0010	EK1101-0010
3	EK1101-0010	CU1123-0010
4	EK1121-0010	CU1123-0010
5	CU1123-0010	EK1101-0010
6	CU1123-0010	CU1123-0010

**Not permitted topologies with Extended Distance components**

The EK1121-0010 EtherCAT junction cannot be used as a 2<sup>nd</sup> component because the EtherCAT port is not an output port. The following figure shows not permitted topologies with Extended Distance components.

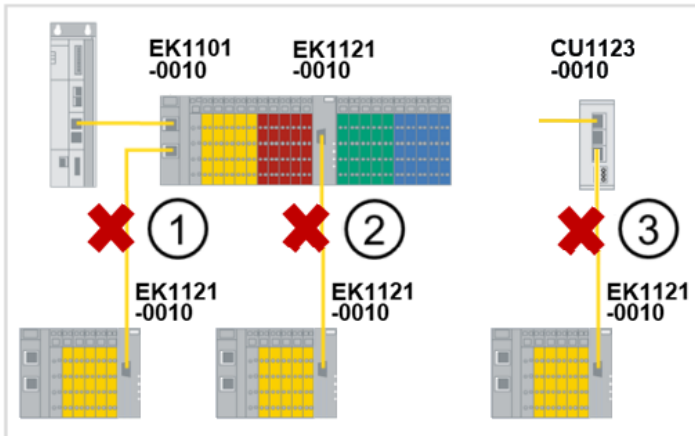

Fig. 9: Not permitted topologies with Extended Distance components

Not permitted topologies with Extended Distance components		
No. in the figure above	1 <sup>st</sup> Component	2 <sup>nd</sup> Component
1	EK1101-0010	EK1121-0010
2	EK1121-0010	EK1121-0010
3	CU1123-0010	EK1101-0010

**Topologies with Extended Distance- and Standard components, distances up to 100 m**

If only one connection of the two Components is configured for Extended Distance, e.g. a connection between a standard EtherCAT Coupler (EK1100) and an EtherCAT Coupler with Extended Distance connection (EK1101-0010), the maximum distance between the stations is 100 m. In the following figure the standard components are marked with a “\*”. Standard components are detected automatically. The parameterization of the EtherCAT ports is not necessary. Examples of possible topologies are shown in the following figure.

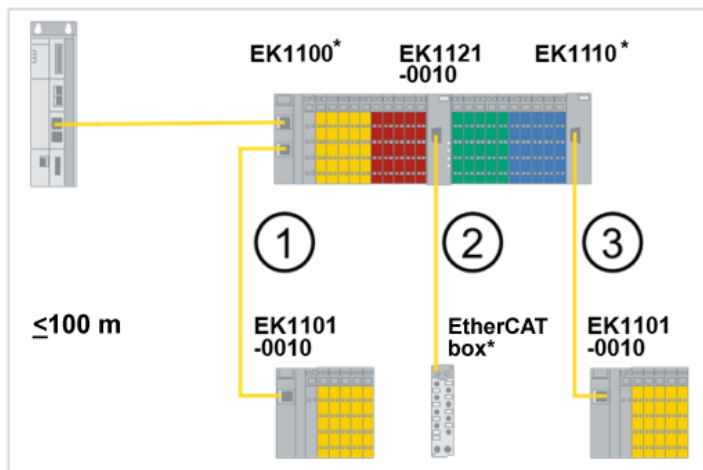

Fig. 10: Topologies with Extended Distance- and Standard components, distances up to 100 m

Not permitted topologies with Extended Distance components, distances up to 100 m		
No. in the figure above	1 <sup>st</sup> Component	2 <sup>nd</sup> Component
1	EK1100*	EK1101-0010
2	EK1121-0010	EtherCAT Box*
3	EK1100*	EK1101-0010

## 2.2.4 EK1101-0080

### 2.2.4.1 Introduction

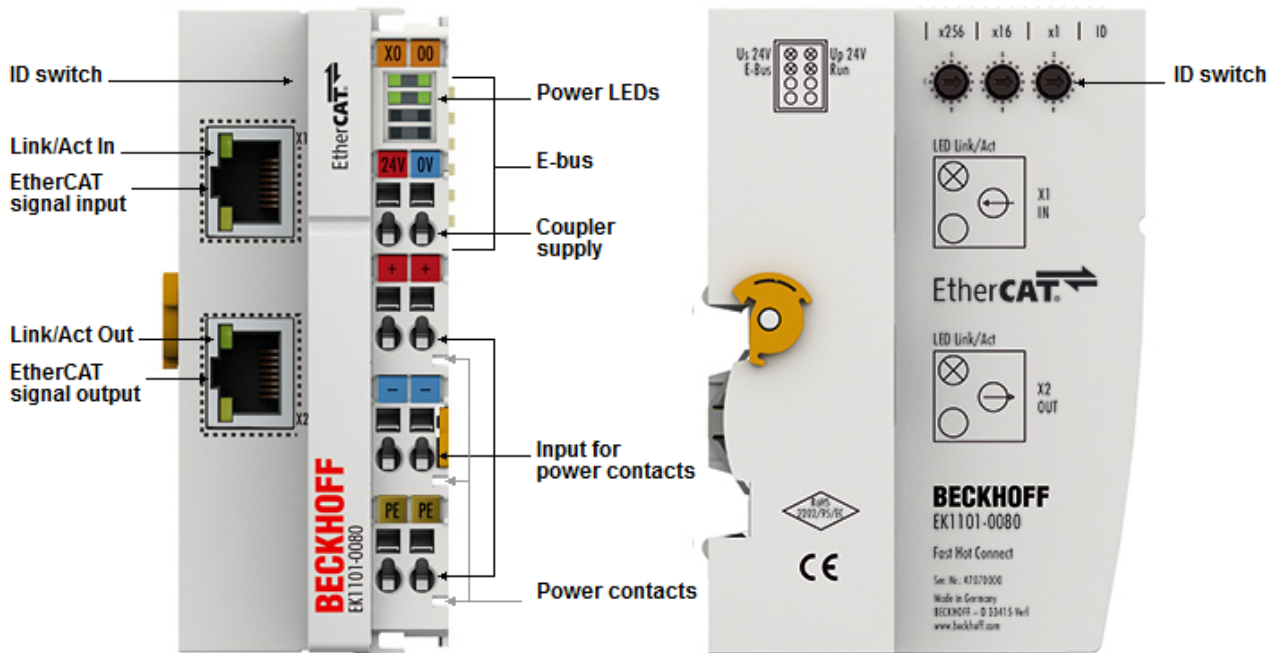

Fig. 11: EK1101-0080

#### EK1101-0080 - EtherCAT coupler with ID switch, Fast Hot Connect

The EK1101-0080 EtherCAT coupler with Fast Hot Connect technology is an extension of the EK1101 coupler.

Hot Connect is an EtherCAT feature for changing topologies through direct coupling or uncoupling during operation. Coupled EtherCAT components are already quickly linked to the data communication after connection as standard. Fast hot-connect technology further reduces the connection time significantly, enabling even faster tool changes. Fast hot-connect ports may only be connected to each other, which is why they are specially identified.

The EK1101-0080 EtherCAT coupler with Fast Hot Connect is complemented by the EK1122-0080 EtherCAT junction with Fast Hot Connect.

#### Quick links

- [EtherCAT basics \[▶ 44\]](#)
- [Configuration instructions](#)
- [Notes on Fast Hot Connect \[▶ 29\]](#)
- [Diagnostic LEDs \[▶ 94\]](#)

## 2.2.4.2 Technical data

Technical data	EK1101-0080
Task in the EtherCAT system	Coupling of EtherCAT Terminals (ELxxxx) to 100BASE-TX EtherCAT networks, Fast Hot Connect technology [ <a href="#">▶ 29</a> ]
Number of EtherCAT Terminals	up to 65535 in the overall system
Number of peripheral signals	max. 4.2 GB addressable IO points
Data transfer medium	Ethernet 100BASE-TX (at least Ethernet CAT5 cable)
Cable length between 2 Bus Couplers	max. 100 m (100BASE-TX)
Protocol / Baud rate	EtherCAT Device Protocol / 100 MBaud
HotConnect	max. number of configurable IDs: 4096
Delay	1 $\mu$ s typ.
Bus connection	2 x RJ45
Power supply	24 V <sub>DC</sub> (-15%/+20%)
Current consumption	70 mA + ( $\sum$ E-bus current)/4
E-bus power supply (5 V) dependent on the ambient temperature (at higher current consumption the <a href="#">EL9410</a> power feed terminal can be used in addition)	max. 2 A (-25 °C ... +55 °C) max. 1 A (> +55 °C)
Power contacts	max. 24 V <sub>DC</sub> , max. 10 A
Electrical isolation	500 V (power contact/supply voltage/EtherCAT)
Dimensions (W x H x D)	approx. 44 mm x 100 mm x 68 mm
Weight	approx. 105 g
Permissible ambient temperature range during operation	-25°C ... +60°C (extended temperature range)
Permissible ambient temperature range during storage	-40°C ... + 85°C
Permissible relative air humidity	95%, no condensation
<a href="#">Mounting</a> [ <a href="#">▶ 50</a> ]	on 35 mm mounting rail according to EN 60715
Vibration / shock resistance	conforms to EN 60068-2-6 / EN 60068-2-27
EMC immunity / emission	conforms to EN 61000-6-2 / EN 61000-6-4
Protection class	IP20
Installation position	variable
Approvals / markings	CE, EAC, UKCA <a href="#">ATEX</a> [ <a href="#">▶ 51</a> ], <a href="#">IECEX</a> [ <a href="#">▶ 52</a> ] <a href="#">cULus</a> [ <a href="#">▶ 56</a> ]

### Ex markings

Standard	Marking
ATEX	II 3 G Ex nA IIC T4 Gc II 3 D Ex tc IIIC T135 °C Dc
IECEX	Ex nA IIC T4 Gc Ex tc IIIC T135 °C Dc

\*) Real applicable approvals/markings see type plate on the side (product marking).

**2.2.4.3 Notes re. EtherCAT Fast Hot Connect technology**

EtherCAT components that support Fast Hot Connect enable a faster fieldbus boot up following the establishment of a connection. The boot up depends in detail on the number of devices, the topology and activated Distributed Clocks. Whereas the normal establishment of a connection and communication takes several seconds, less than 1 second is possible with FHC components.

**Properties and system behavior**

- Fast Hot Connect is supported from TwinCAT 2.11R3 Build 2221.
- Fast Hot Connect ports are specially marked.



Fig. 12: Identification of FHC port at EK1122-0080 and EK1101-0080

- Standard EtherCAT devices may not be connected to Fast Hot Connect ports. This is to be ensured by measures on the application side, which is easy to implement by means of the topology change that is usually carried out mechanically in such applications.

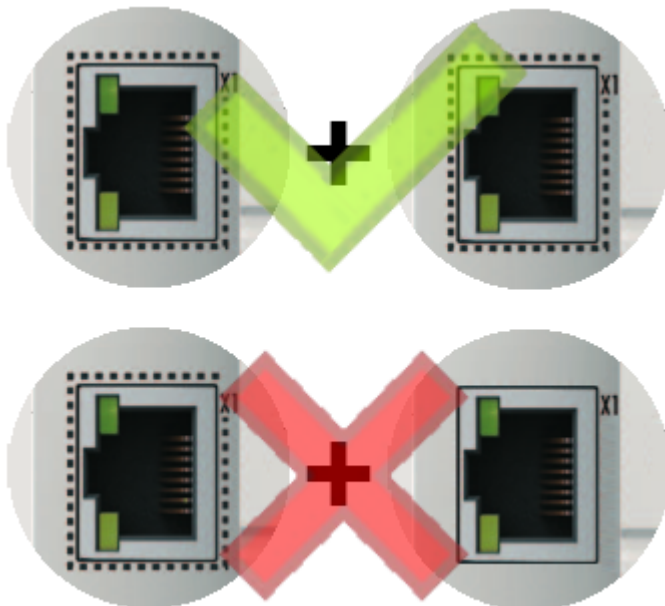

Fig. 13: Recommended combination of Ethernet ports

- If corresponding ports are nevertheless connected, a power reset of the devices involved (branch terminal and coupler/box) is required.

- With Fast Hot Connect devices the establishment of an Ethernet connection is accelerated compared to the normal Fast Ethernet connection.  
If in addition the use of Distributed Clocks functions is omitted in the entire topology, then the resynchronization time of the components is also dispensed with. Group boot up of < 1 second is then possible, from plugging in the Ethernet connection to the OP state.
- An incorrect port allocation is detected in the TwinCAT ADS Logger

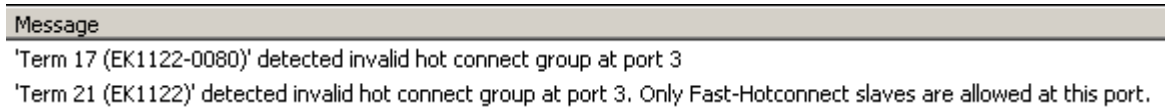

Fig. 14: Detection of incorrect port allocation in the TwinCAT logger

**Configuration**

The configuration of Fast Hot Connect groups in the TwinCAT System Manager takes place in exactly the same way as Hot Connect groups, specifying the associated group ID.

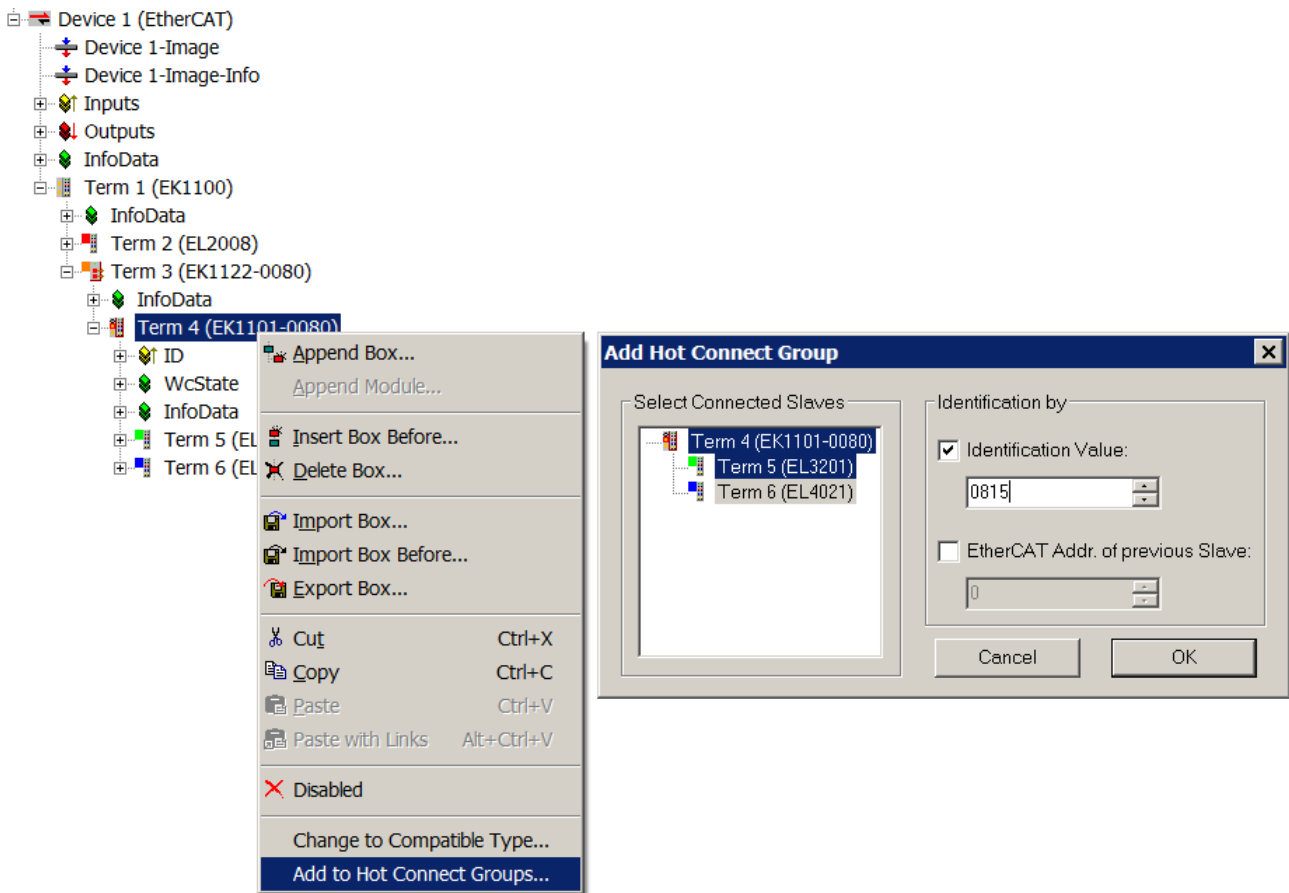

Fig. 15: Configuration of a Fast Hot Connect group

Corresponding Fast Hot Connect ports are marked red in the TwinCAT System Manager.

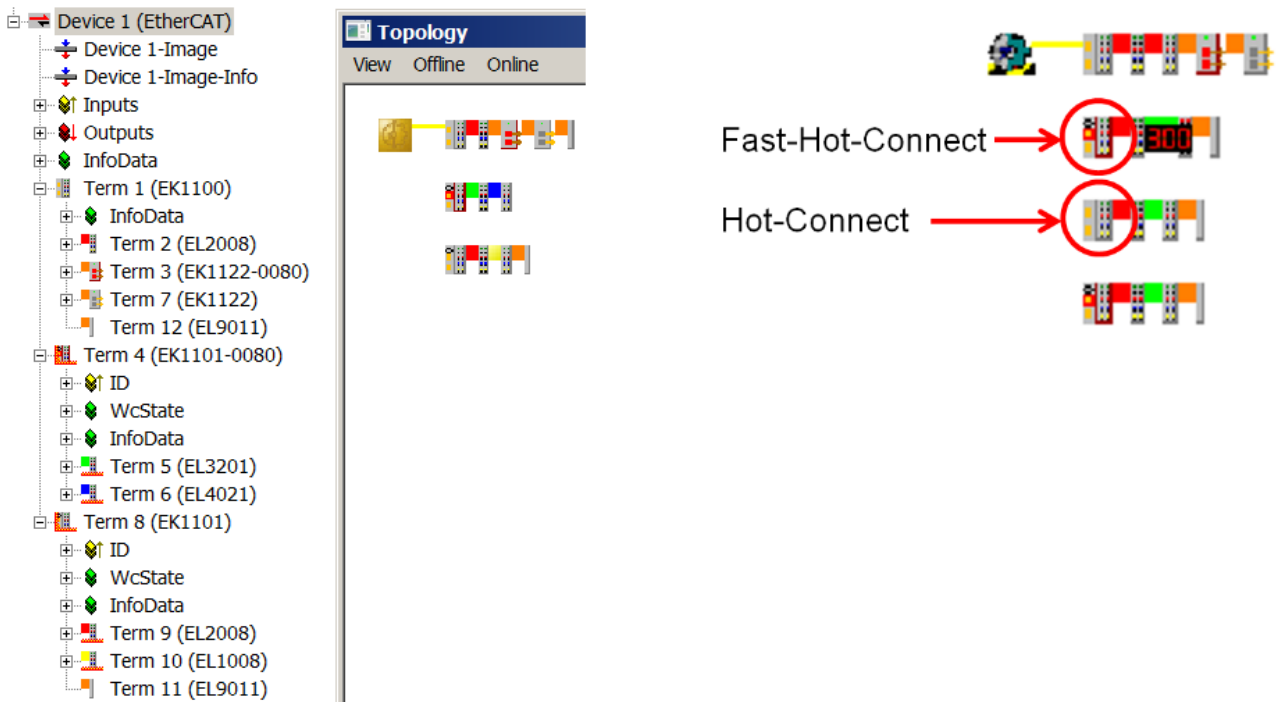

Fig. 16: Marking in the TwinCAT System Manager

A configuration of FHC groups is possible only if at least 1 corresponding junction is present e.g. EK1122-0080.

**Distributed Clocks**

If no Distributed Clocks functions are used, this is visible in the master settings by the absence of “DC in use”:

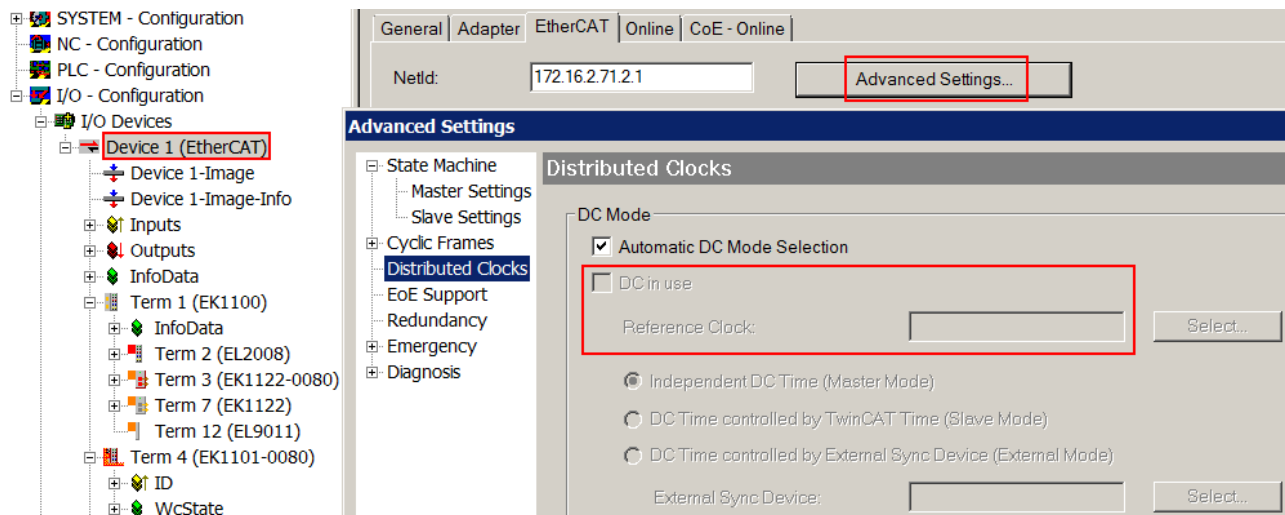

Fig. 17: DC master setting

This setting is automatically selected by the System Manager if there are no EtherCAT slaves in the configuration in which Distributed Clocks is activated. “DC in use” should not be randomly deactivated by the user, because otherwise these devices will no longer function.

## 2.3 Coupler with M8 connection

### 2.3.1 EK1100-0008

#### 2.3.1.1 Introduction

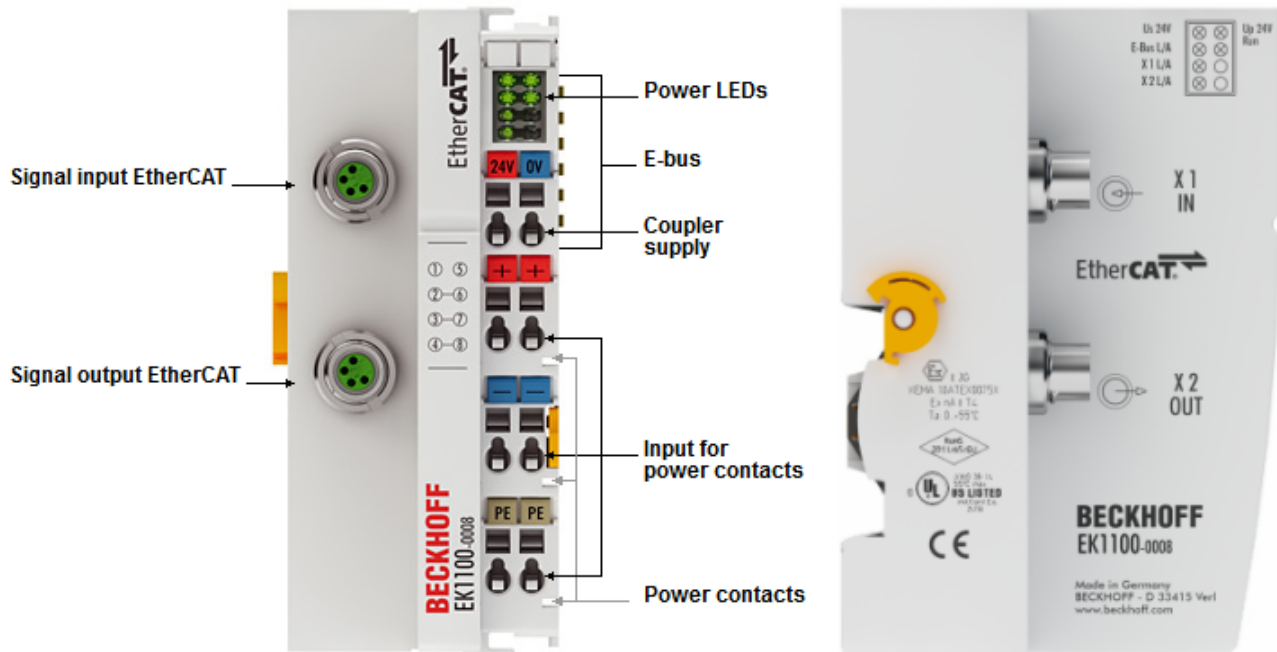

Fig. 18: EK1100-0008

#### EK1100-0008 EtherCAT coupler (M8 connection)

The EK1100-0008 coupler connects EtherCAT with the EtherCAT Terminals (ELxxxx/ESxxxx). One station consists of an EK1100-0008 coupler, any number of EtherCAT Terminals and a bus end terminal. The coupler converts the passing telegrams from Ethernet 100BASE-TX to E-bus signal representation. Instead of the two RJ45 sockets as in the EK1100, the EK1100-0008 has two M8 sockets that are compatible with the EtherCAT Boxes.

The upper Ethernet interface is used to connect the coupler to the network; the lower M8 socket serves for the optional connection of further EtherCAT devices in the same strand.

The coupler supplies the connected terminals with the necessary E-bus current for communication. The coupler can supply a maximum of 5 V/2 A. Power feed terminals (e.g. EL9410) must be integrated if more current is required.

In the EtherCAT network, the EK1100-0008 coupler can be installed anywhere in the Ethernet signal transfer section (100BASE-TX) – except directly at the switch. If Ethernet cables with adequate performance are used, e.g. ZK1090-3131-1xxx, line lengths of 100 m are possible via M8.

#### Quick links

- [EtherCAT basics](#) [► 44]
- [Configuration instructions](#) [► 77]
- [Diagnostic LEDs](#) [► 93]



**2.3.1.2 Technical data**

Technical data	EK1100-0008
Task in the EtherCAT system	Coupling of EtherCAT Terminals (ELxxxx) to 100BASE-TX EtherCAT networks
Number of EtherCAT Terminals	up to 65535 in the overall system
Data transfer medium	Ethernet 100BASE-TX (at least Ethernet CAT5 cable)
Cable length between 2 Bus Couplers	max. 100 m (100BASE-TX)
Data transfer rates	100 Mbaud
Configuration	not required
Delay	1 µs typ.
Bus interface	2 x M8
Power supply	24 V <sub>DC</sub> (-15%/+20%)
Current consumption from US	70 mA + (∑ E-bus current/4)
Current consumption from UP	Load
E-bus power supply	max. 2 A (-25 °C ... +55 °C) max. 1 A (> +55 °C)
Power contacts	max. 24 V <sub>DC</sub> , max. 10 A
Electrical isolation	500 V (power contact/supply voltage/EtherCAT)
Dimensions (W x H x D)	approx. 44 mm x 100 mm x 68 mm
Weight	approx. 105 g
Permissible ambient temperature range during operation	-25°C ... +60°C
Permissible ambient temperature range during storage	-40°C ... + 85°C
Permissible relative air humidity	95%, no condensation
Mounting [► 50]	on 35 mm mounting rail according to EN 60715
Enhanced mechanical load capacity	yes, see also <a href="#">Installation instructions [► 60]</a> for enhanced mechanical load capacity
Vibration / shock resistance	conforms to EN 60068-2-6 / EN 60068-2-27
EMC immunity / emission	conforms to EN 61000-6-2 / EN 61000-6-4
Protection class	IP20
Installation position	variable
Approvals / markings	CE, EAC, UKCA <a href="#">ATEX [► 51]</a> , <a href="#">IECEX [► 52]</a> <a href="#">cULus [► 56]</a>

**Ex markings**

Standard	Marking
ATEX	II 3 G Ex nA IIC T4 Gc II 3 D Ex tc IIIC T135 °C Dc
IECEX	Ex nA IIC T4 Gc Ex tc IIIC T135 °C Dc

\*) Real applicable approvals/markings see type plate on the side (product marking).

## 2.3.2 EK1101-0008

### 2.3.2.1 Introduction

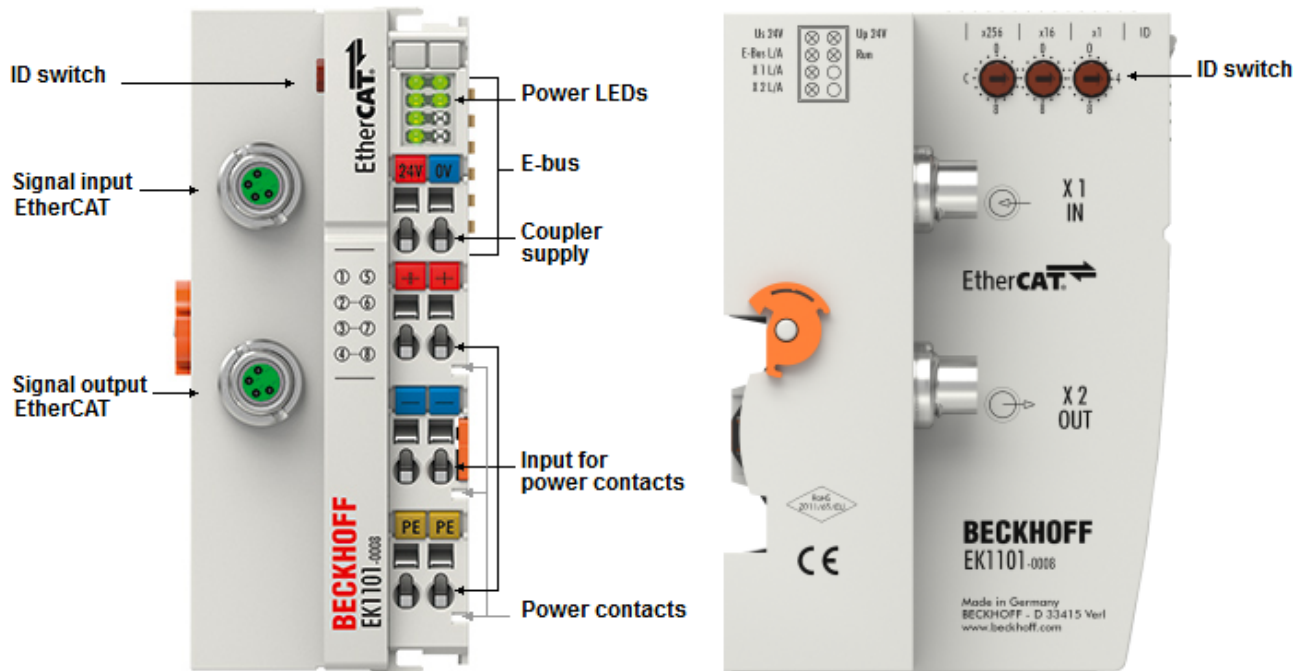

Fig. 19: EK1101-0008

#### EK1101-0008 - EtherCAT coupler with ID switch (M8 connection)

The EK1101-0008 coupler connects EtherCAT with the EtherCAT Terminals (ELxxxx). Compared with the EK1101, the EK1101-0008 has two M8 sockets, which are compatible with the EtherCAT Box modules.

- The coupler is connected to the network via the upper Ethernet interface.
- The lower M8 socket may be used to connect further EtherCAT devices in the same strand.

In the EtherCAT network, the EK1101-0008 coupler can be installed anywhere in the Ethernet signal transfer section (100BASE-TX) – except directly at the switch. If Ethernet cables with adequate performance are used, e.g. ZK1090-3131-1xxx, line lengths of 100 m are possible via M8.

The EK1101-0008 has three hexadecimal ID switches for assigning an ID to a group of EtherCAT components. This group can then be located at any position within the EtherCAT network. Variable topologies are therefore easily implementable.

#### Quick links

- [EtherCAT basics](#) [▶ 44]
- [Configuration instructions](#) [▶ 77]
- [Diagnostic LEDs](#) [▶ 94]

**2.3.2.2 Technical data**

Technical data	EK1101-0008
Task in the EtherCAT system	Coupling of EtherCAT Terminals (ELxxxx) to 100BASE-TX EtherCAT networks, with identity recognition
Number of EtherCAT Terminals	up to 65535 in the overall system
Number of peripheral signals	Max. 4.2 GB addressable IO points
Data transfer medium	Ethernet/EtherCAT cable (min. CAT 5), shielded
Cable length between 2 Bus Couplers	max. 100 m (100BASE-TX)
Data transfer rates	100 Mbit/s
HotConnect	max. number of configurable IDs: 4096
Delay	typ. approx. 1 $\mu$ s
Bus interface	2 x M8, shielded, screw type,
Power supply	24 V <sub>DC</sub> (-15%/+20%)
Current consumption from U <sub>S</sub>	70 mA + ( $\sum$ E-bus current/4)
Current consumption from U <sub>P</sub>	Load
E-bus power supply	max. 2 A (-25 °C ... +55 °C) max. 1 A (> +55 °C)
Power contacts	max. 24 V <sub>DC</sub> , max. 10 A
Electrical isolation	500 V (power contact/supply voltage/EtherCAT)
Dimensions (W x H x D)	approx. 44 mm x 100 mm x 68 mm
Weight	approx. 110 g
Permissible ambient temperature range during operation	-25°C ... +60°C
Permissible ambient temperature range during storage	-40°C ... + 85°C
Permissible relative air humidity	95%, no condensation
<u>Mounting</u> [ <a href="#">▶ 50</a> ]	on 35 mm mounting rail according to EN 60715
Vibration / shock resistance	conforms to EN 60068-2-6/EN 60068-2-27
EMC immunity / emission	conforms to EN 61000-6-2 / EN 61000-6-4
Protection class	IP20
Installation position	variable
Approvals / markings	CE, EAC, UKCA

\*) Real applicable approvals/markings see type plate on the side (product marking).

## 2.4 Coupler with optical fiber connection

### 2.4.1 EK1501

#### 2.4.1.1 Introduction

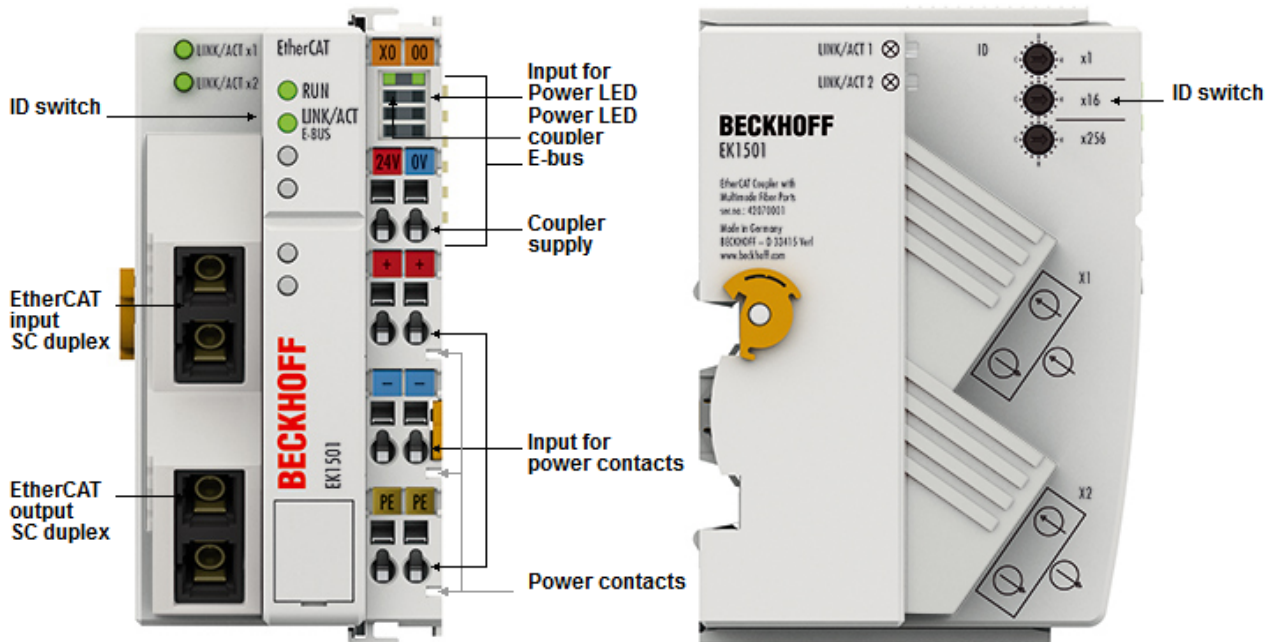

Fig. 20: EK1501

#### EK1501 EtherCAT coupler with ID switch, multimode fiber-optic connection

The EK1501 coupler connects the EtherCAT Device Protocol with the EtherCAT Terminals (ELxxxx/ESxxxx/EMxxxx). One station consists of a coupler, any number of EtherCAT Terminals and a bus end terminal, e.g. EL9011.

The coupler converts the telegrams from Ethernet 100BASE-FX to E-bus signal representation in passing with minimum latency. The upper Ethernet interface is used to connect the coupler to the network; the lower SC socket serves for the optional connection of further EtherCAT devices in the same strand.

The coupler supplies the connected terminals with the necessary E-bus current for communication. The coupler can supply a maximum of 5 V/2 A. Power feed terminals (e.g. EL9410) must be integrated if more current is required.

In the EtherCAT network, the coupler is used at an arbitrary place in the Ethernet signal transmission range (100BASE-FX). The coupler thereby processes exclusively unaddressed MAC Broadcast telegrams of the type EtherCAT Device Protocol from the EtherCAT master. Since directed addressing via MAC Unicast or IP addressing is not used, neither a switch nor a router can be used.

The multimode glass fiber connection enables distances of up to 2 km between two couplers.

The coupler supports the HotConnect technique; see the basic [EtherCAT](#) documentation regarding this. The characteristics of the EK1501 in relation to this are:

- the ID can be set on the device via three rotary selection switches within the range 0..4095 (hexadecimal)
- the ID is readable online by the EtherCAT master via the process data
- if the EtherCAT master supports HotConnect, then an I/O group can be adopted dynamically into the EtherCAT communication. This group can then be located at any position within the EtherCAT network. Variable topologies are therefore easily implementable.

**Quick links**

- [EtherCAT basics \[▶ 44\]](#)
- [Application notes \[▶ 78\]](#)
- [Diagnostic LEDs \[▶ 95\]](#)

**2.4.1.2 Technical data**

Technical data	EK1501
Task in the EtherCAT system	Coupling of EtherCAT Terminals (ELxxxx) to 100BASE-FX EtherCAT networks
Number of EtherCAT Terminals	up to 65535 in the overall system
Number of peripheral signals	max. 4.2 GB addressable IO points
Cable length between 2 Bus Couplers	Recommended max. 2 km (100BASE-FX)
Protocol / Baud rate	EtherCAT Device Protocol / 100 MBaud
HotConnect	max. number of configurable IDs: 4096
Delay	1 µs typ.

Optical data	EK1501
Data transfer medium	Multimode glass fiber (MM)
Transceiver wavelength	typically 1300 nm
Bus connection	2 x SC Duplex
Minimum output power (opt.)	62,5/125 µm, NA = 0,275: -20 dBm avg. 50/125 µm, NA = 0,2: 23,5 dBm avg.
Min. necessary optical input power (sensitivity)	-31 dBm

General data	EK1501
Power supply	24 V <sub>DC</sub> (-15%/+20%)
Current consumption	130 mA + (∑ E-bus current)/4
E-bus power supply (5 V) dependent on the ambient temperature (at higher current consumption the <a href="#">EL9410</a> power feed terminal can be used in addition)	max. 2 A (-25 °C ... +55 °C) max. 1 A (> +55 °C)
Power contacts	max. 24 V <sub>DC</sub> , max. 10 A
Electrical isolation	500 V (power contact/supply voltage/EtherCAT)
Dimensions (W x H x D)	approx. 49 mm x 100 mm x 70 mm
Weight	approx. 190 g
Permissible ambient temperature range during operation	-25°C ... +60°C (extended temperature range)
Permissible ambient temperature range during storage	-40°C ... + 85°C
Permissible relative air humidity	95%, no condensation
<a href="#">Mounting [▶ 50]</a>	on 35 mm mounting rail according to EN 60715

Standards and approvals	EK1501
Vibration / shock resistance	conforms to EN 60068-2-6 / EN 60068-2-27
EMC immunity / emission	conforms to EN 61000-6-2 / EN 61000-6-4
Protection class	IP20
Installation position	variable
Approvals / markings	CE, EAC, UKCA <a href="#">ATEX [▶ 51]</a> <a href="#">cULus [▶ 56]</a>

**Ex marking**

Standard	Marking
ATEX	II 3 G Ex nA IIC T4 Gc

\*) Real applicable approvals/markings see type plate on the side (product marking).

## 2.4.2 EK1501-0010

### 2.4.2.1 Introduction

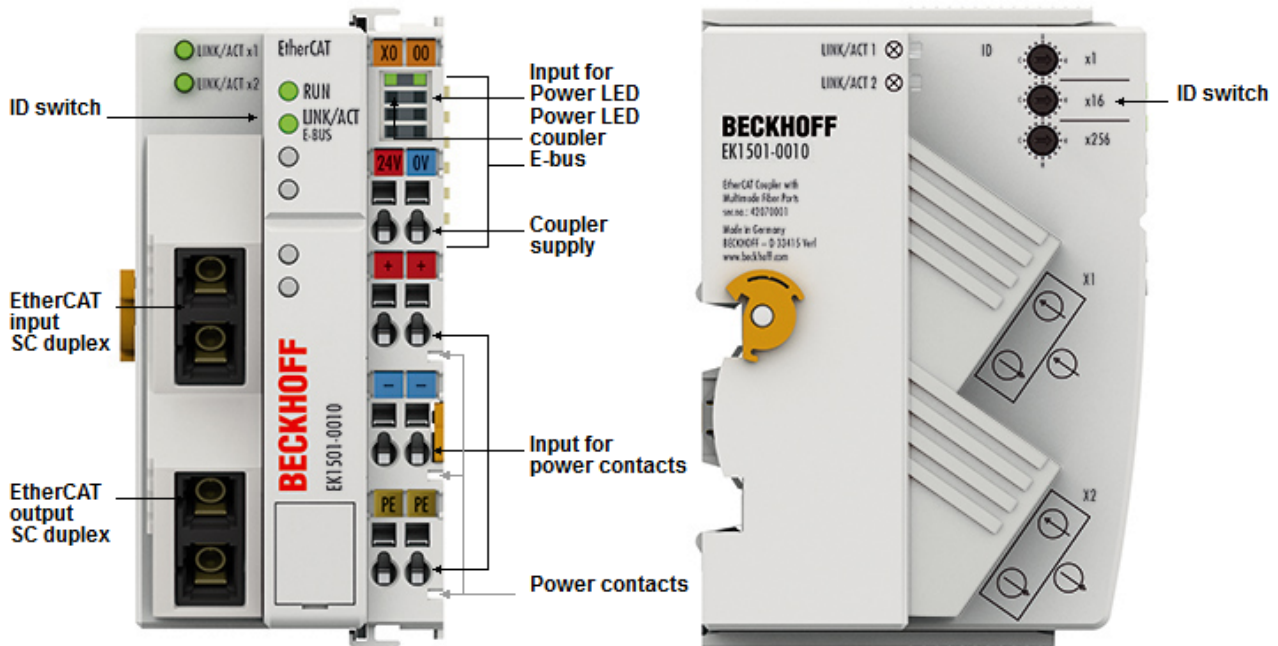

Fig. 21: EK1501-0010

#### EK1501-0010 EtherCAT coupler with ID switch, single-mode fiber-optic connection

The EK1501-0010 coupler differs from the EK1501 only in the transceiver used. Transmission ranges of up to 20 km can be attained with the single-mode technique using appropriate fiber-optic cables.

An attenuation budget of 10 dBm is available between the EK1501-0010 and the associated EK1521-0010 junction. The following factors can be taken as a basis for the estimation of the attenuation:

- 2x SC connector: 0.25 dBm each
- typ. fiber-optic cable with 0.4 dB/km attenuation

The sum of all attenuations may not exceed 10 dBm. The installed fiber optic section is to be validated by measurement if necessary.

#### Quick links

- [EtherCAT basics \[▶ 44\]](#)
- [Application notes \[▶ 78\]](#)
- [Diagnostic LEDs \[▶ 95\]](#)

### 2.4.2.2 Technical data

Technical data	EK1501-0010
Task in the EtherCAT system	Coupling of EtherCAT Terminals (ELxxxx) to 100BASE-FX EtherCAT networks
Number of EtherCAT Terminals	up to 65535 in the overall system
Number of peripheral signals	max. 4.2 GB addressable IO points
Cable length between 2 Bus Couplers	Recommended max. 20 km (100BASE-FX)
Protocol / Baud rate	EtherCAT Device Protocol / 100 MBaud
HotConnect	max. number of configurable IDs: 4096
Delay	1 $\mu$ s typ.

Optical data	EK1501-0010
Data transfer medium	Single mode glass fiber (SM)
Transceiver wavelength	typically 1300 nm
Bus connection	2 x SC Duplex
Minimum output power (opt.)	-15 dBm (until year of manufacture 2022) -5 dBm (from year of manufacture 2023)
Min. necessary optical input power (sensitivity)	-25 dBm (until year of manufacture 2022) -35 dBm (from year of manufacture 2023)

General data	EK1501-0010
Power supply	24 V <sub>DC</sub> (-15%/+20%)
Current consumption	150 mA + ( $\sum$ E-bus current)/4
E-bus power supply (5 V) dependent on the ambient temperature (at higher current consumption the <a href="#">EL9410</a> power feed terminal can be used in addition)	max. 2 A (-25 °C ... +55 °C) max. 1 A (> +55 °C)
Power contacts	max. 24 V <sub>DC</sub> , max. 10 A
Electrical isolation	500 V (power contact/supply voltage/EtherCAT)
Dimensions (W x H x D)	approx. 49 mm x 100 mm x 70 mm
Weight	approx. 190 g
Permissible ambient temperature range during operation	-25°C ... +60°C (extended temperature range)
Permissible ambient temperature range during storage	-40°C ... + 85°C
Permissible relative air humidity	95%, no condensation
Mounting [ <a href="#">▶ 50</a> ]	on 35 mm mounting rail according to EN 60715

Standards and approvals	EK1501-0010
Vibration / shock resistance	conforms to EN 60068-2-6 / EN 60068-2-27
EMC immunity / emission	conforms to EN 61000-6-2 / EN 61000-6-4
Protection class	IP20
Installation position	variable
Approvals / markings	CE, EAC, UKCA <a href="#">ATEX</a> [ <a href="#">▶ 51</a> ] <a href="#">cULus</a> [ <a href="#">▶ 56</a> ]

#### Ex marking

Standard	Marking
ATEX	II 3 G Ex nA IIC T4 Gc



\*) Real applicable approvals/markings see type plate on the side (product marking).

## 2.5 Coupler with POF connection

### 2.5.1 EK1541

#### 2.5.1.1 Introduction

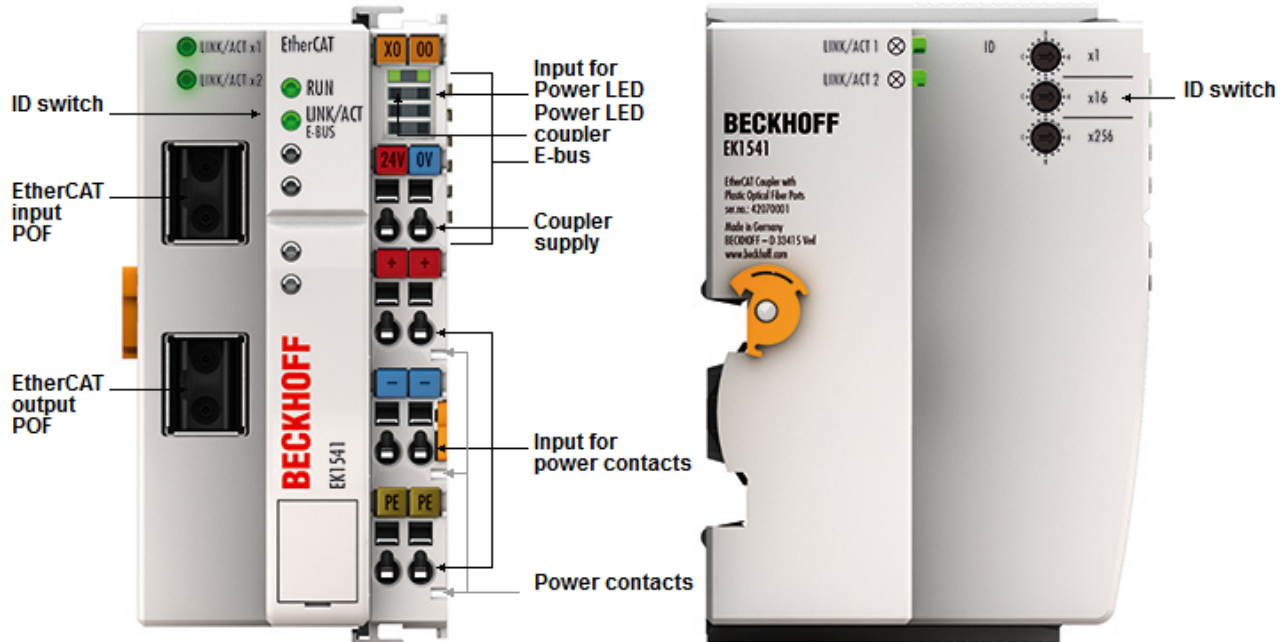

Fig. 22: EK1541

#### EK1541 EtherCAT coupler with ID switch, POF connection

The EK1541 Coupler connects EtherCAT with the EtherCAT Terminals (ELxxxx). A station consists of an EK1541 coupler, any number of EtherCAT Terminals, an EL9011 bus end cap or an EK1110 EtherCAT extender.

The coupler converts the telegrams from Ethernet 100BASE-FX-POF physics to E-bus signal representation in passing with minimum latency. The Polymeric Optical Fiber (POF) connection enables distances of up to 50 m between two couplers. Unlike the glass fiber, the POF fiber is easily wireable in the field. The EK1541 has three hexadecimal ID switches for assigning an ID to a group of EtherCAT components.

The coupler supplies the connected terminals with the necessary E-bus current for communication. The coupler can supply a maximum of 5 V/2 A. Power feed terminals (e.g. EL9410) must be integrated if more current is required.

The device supports the HotConnect procedure, see [EtherCAT](#) documentation. The characteristics of the EK1541 in relation to this are:

- ID can be set on the device via three rotary selector switches within the range 0 to 4095 (hexadecimal)
- the ID is readable online by the EtherCAT master via the process data
- if the EtherCAT master supports HotConnect, then an I/O group can be adopted dynamically into the EtherCAT communication. This group can then be located at any position within the EtherCAT network. Variable topologies are therefore easily implementable.

#### Quick links

- [EtherCAT basics](#) [▶ 44]
- [Application notes](#) [▶ 87]
- [Diagnostic LEDs](#) [▶ 95]

**2.5.1.2 Technical data**

Technical data	EK1541
Task in the EtherCAT system	Coupling of EtherCAT Terminals (ELxxxx) to 100BASE-FX EtherCAT POF networks
Number of EtherCAT Terminals	up to 65535 in the overall system
Number of peripheral signals	max. 4.2 GB addressable IO points
Cable length between 2 Bus Couplers	max. 50 m (100BASE-FX-POF)
Protocol / Baud rate	EtherCAT Device Protocol / 100 Mbaud
HotConnect	max. number of configurable IDs: 4096
Delay	1 µs typ.

Optical data	EK1541
Data transfer medium	Polymeric Optical Fiber
Transceiver wavelength	650 nm Laser class 1, see Note [► 97]
Bus connection	2 x versatile link for POF duplex connector (connector set ZS1090-0008)
Minimum output power (opt.)	NA = 0,5: -13,5 dBm
Min. necessary optical input power (sensitivity)	-26 dBm

General data	EK1541
Power supply	24 V <sub>DC</sub> (-15%/+20%)
Current consumption 24 V <sub>DC</sub>	130 mA + (∑ E-bus current/4)
Current consumption via E-bus	-
E-bus power supply (5 V) dependent on the ambient temperature (at higher current consumption the <a href="#">EL9410</a> power feed terminal can be used in addition)	max. 2 A (-25 °C ... +55 °C) max. 1 A (> +55 °C)
Power contacts	max. 24 V <sub>DC</sub> , max. 10 A
Electrical isolation	500 V (power contact/supply voltage/EtherCAT)
Dimensions (W x H x D)	approx. 49 mm x 100 mm x 70 mm
Weight	approx. 190 g
Permissible ambient temperature range during operation	-25°C ... +60°C (extended temperature range)
Permissible ambient temperature range during storage	-40°C ... + 85°C
Permissible relative air humidity	95%, no condensation
Mounting [► 50]	on 35 mm mounting rail according to EN 60715

Standards and approvals	EK1541
Vibration / shock resistance	conforms to EN 60068-2-6 / EN 60068-2-27
EMC immunity / emission	conforms to EN 61000-6-2 / EN 61000-6-4
Protection class	IP20
Installation position	variable
Approvals / markings	CE, EAC, UKCA cULus [► 56]

\*) Real applicable approvals/markings see type plate on the side (product marking).

### 3 Basics communication

#### 3.1 EtherCAT basics

Please refer to the [EtherCAT System Documentation](#) for the EtherCAT fieldbus basics.

#### 3.2 EtherCAT coupler port allocation

According to the EtherCAT specification, an ESC (EtherCAT Slave Controller, hardware processing unit of the EtherCAT protocol) can have 1 to 4 ports, which it controls itself. Via an open port it can handle outgoing and incoming Ethernet traffic.

The following figure shows the direction of data flow in a fully connected EK1100 (or EK1100-0008) as an example:

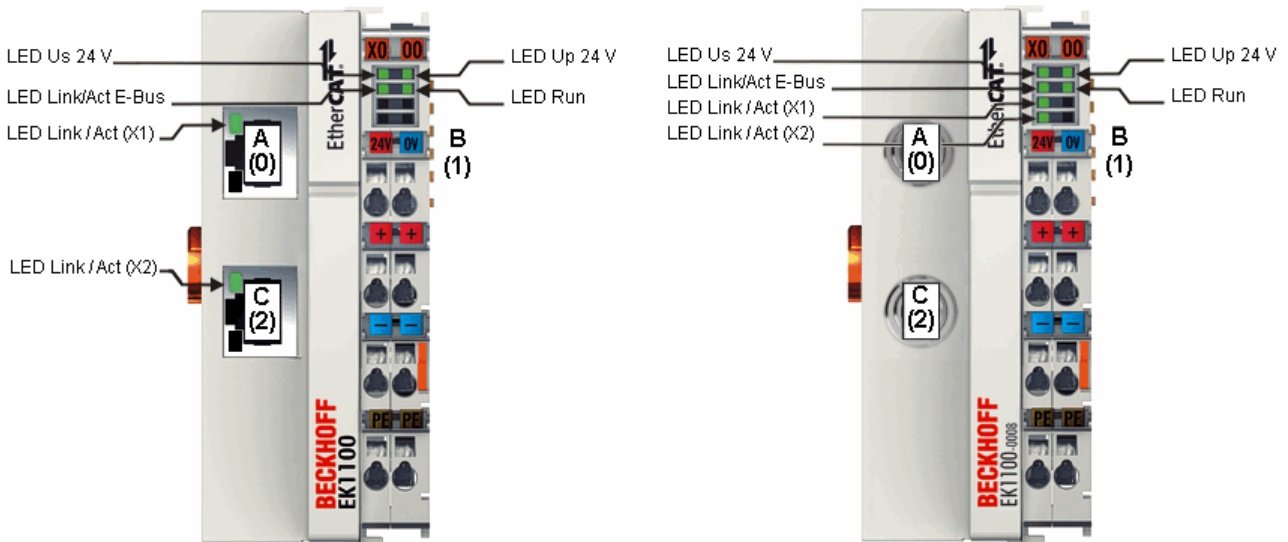

Fig. 23: Example: EK1100 / EK1100-0008 EtherCAT coupler with 3 ports

The port assignment in the case of the EK1101, EK1501 and EK1501-0010, EK1814 applies accordingly.

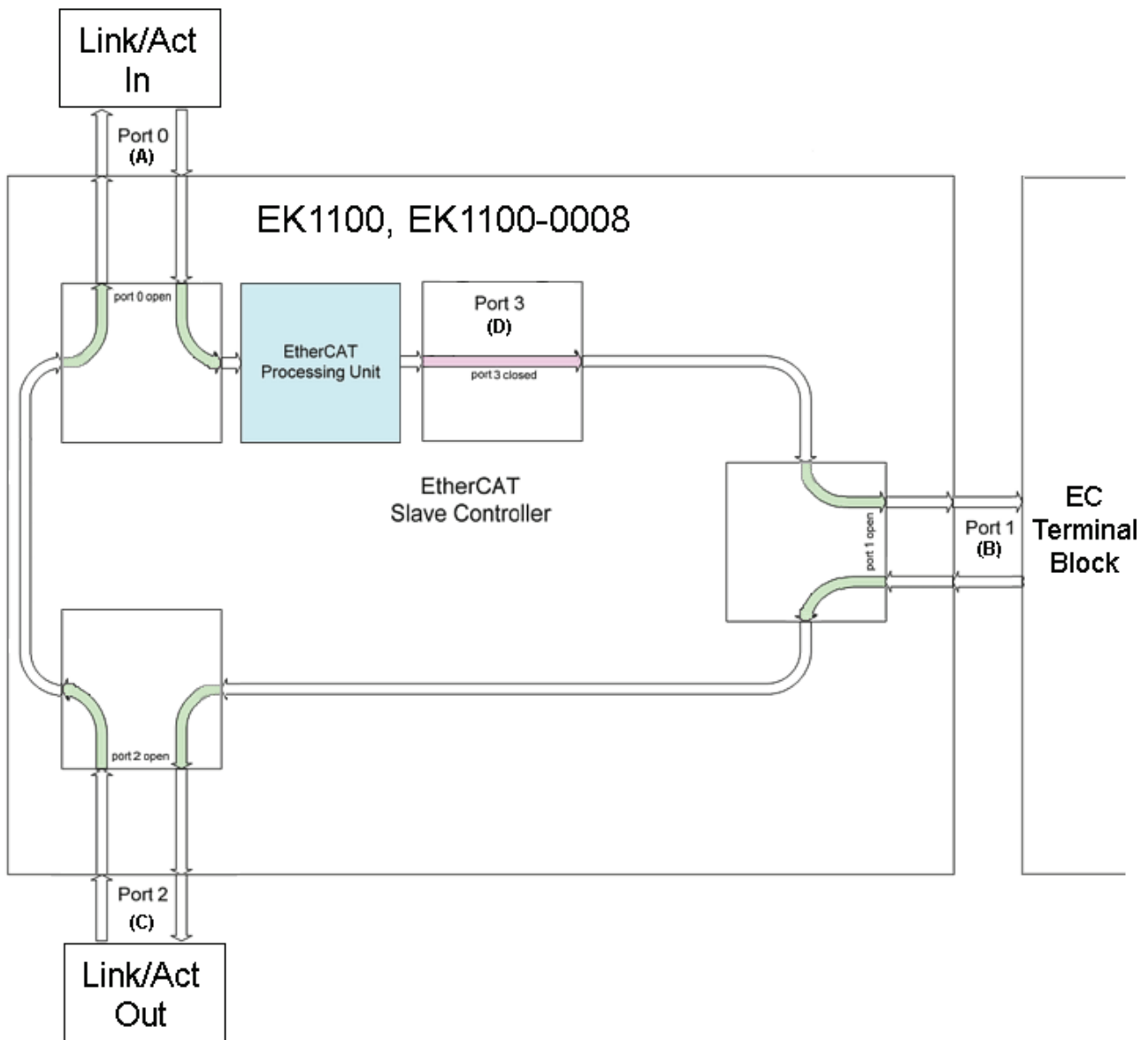

Fig. 24: Internal and external port assignment for Bus Coupler EK1100 and EK1100-0008

**Frame processing sequence**

- The EtherCAT frame arriving at the EtherCAT signal input is passed on by Port 0 (A) to the EtherCAT processing unit.
- The EtherCAT frame arrives at Port 1 (B) and the data frame departs via Port 1 (B) to the following slave in the EtherCAT terminal network (if a slave is connected there and reports 'Link').
- After the arrival of the data frame at Port 1 (B) from the terminal network, this is passed on to Port 2 (C) and leaves the coupler at the following EtherCAT output (if a slave is connected there and reports 'Link').
- The data frame arrives at Port 2 (C). This is now forwarded to port 0 (A) and leaves the EK1100 / EK1100-0008 via the EtherCAT input.

**Processing of the data**

**i** The data in the EtherCAT datagrams are processed only between Ports 0 (A) and 3 (D) in the EtherCAT processing unit. The non-implemented (internal) Port 3 (D) is considered to be closed and passes on the datagram to Port 1 (B).

### 3.3 EtherCAT State Machine

The state of the EtherCAT slave is controlled via the EtherCAT State Machine (ESM). Depending upon the state, different functions are accessible or executable in the EtherCAT slave. Specific commands must be sent by the EtherCAT master to the device in each state, particularly during the bootup of the slave.

A distinction is made between the following states:

- Init
- Pre-Operational
- Safe-Operational and
- Operational
- Boot

The regular state of each EtherCAT slave after bootup is the OP state.

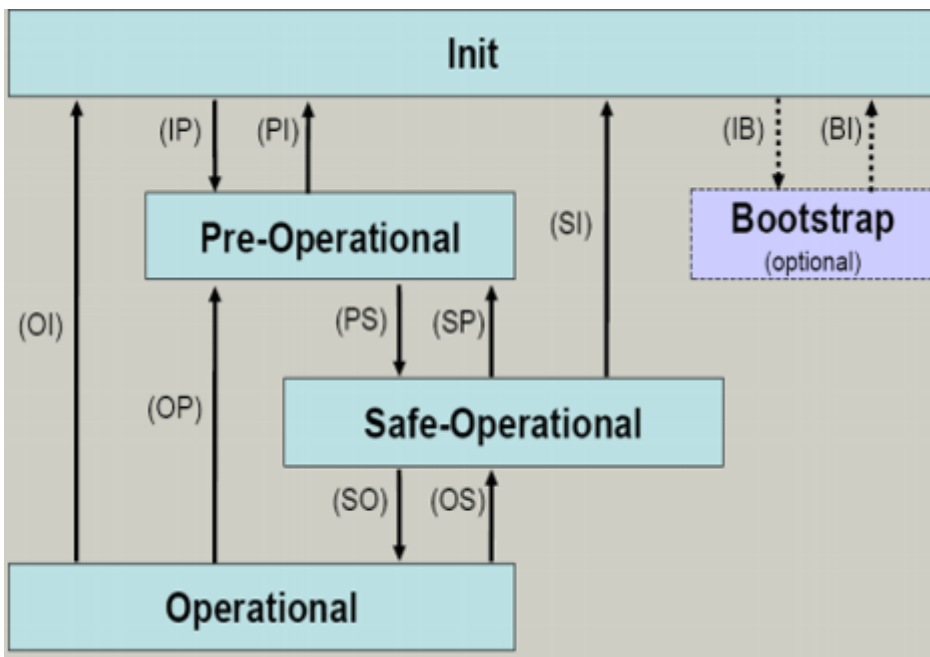

Fig. 25: States of the EtherCAT State Machine

#### Init

After switch-on the EtherCAT slave in the *Init* state. No mailbox or process data communication is possible. The EtherCAT master initializes sync manager channels 0 and 1 for mailbox communication.

#### Pre-Operational (Pre-Op)

During the transition between *Init* and *Pre-Op* the EtherCAT slave checks whether the mailbox was initialized correctly.

In *Pre-Op* state mailbox communication is possible, but not process data communication. The EtherCAT master initializes the sync manager channels for process data (from sync manager channel 2), the FMMU channels and, if the slave supports configurable mapping, PDO mapping or the sync manager PDO assignment. In this state the settings for the process data transfer and perhaps terminal-specific parameters that may differ from the default settings are also transferred.

#### Safe-Operational (Safe-Op)

During transition between *Pre-Op* and *Safe-Op* the EtherCAT slave checks whether the sync manager channels for process data communication and, if required, the distributed clocks settings are correct. Before it acknowledges the change of state, the EtherCAT slave copies current input data into the associated DP-RAM areas of the EtherCAT slave controller (ECSC).

In *Safe-Op* state mailbox and process data communication is possible, although the slave keeps its outputs in a safe state, while the input data are updated cyclically.

### ● Outputs in SAFEOP state

**I** The default set watchdog monitoring sets the outputs of the module in a safe state - depending on the settings in SAFEOP and OP - e.g. in OFF state. If this is prevented by deactivation of the watchdog monitoring in the module, the outputs can be switched or set also in the SAFEOP state.

### Operational (Op)

Before the EtherCAT master switches the EtherCAT slave from *Safe-Op* to *Op* it must transfer valid output data.

In the *Op* state the slave copies the output data of the masters to its outputs. Process data and mailbox communication is possible.

### Boot

In the *Boot* state the slave firmware can be updated. The *Boot* state can only be reached via the *Init* state.

In the *Boot* state mailbox communication via the *file access over EtherCAT* (FoE) protocol is possible, but no other mailbox communication and no process data communication.

## 3.4 CoE - Interface: notes

This device has no CoE.

Detailed information on the CoE interface can be found in the [EtherCAT system documentation](#) on the Beckhoff website.

## 3.5 EKxxxx - Optional Distributed Clocks support

### Basic principles Distributed Clocks (DC)

The EtherCAT Distributed Clocks system comprises local clocks that are integrated in the EtherCAT slaves and are synchronized by the EtherCAT master via special datagrams. Not all EtherCAT slaves support the Distributed Clocks procedure. It is only supported by slaves whose function requires it. In the TwinCAT System Manager a slave indicates its DC capability by showing "DC" in the settings dialog.

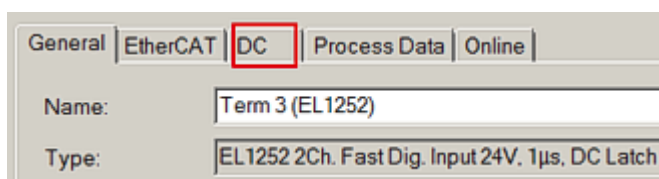

Fig. 26: DC tab for indicating the Distributed Clocks function

Once of these local clocks is the reference clock, based on which all other clocks are synchronized. See also explanatory notes in the [Basic EtherCAT documentation](#). The reference clock must be the first DC-capable EtherCAT slave. By default TwinCAT therefore selects the first DC-capable device as reference clock. This is shown (and can be modified by the user) under advanced properties of the EtherCAT master. The standard setting should not be changed, except in cases where external synchronization is recommended in the relevant documentation, for example.

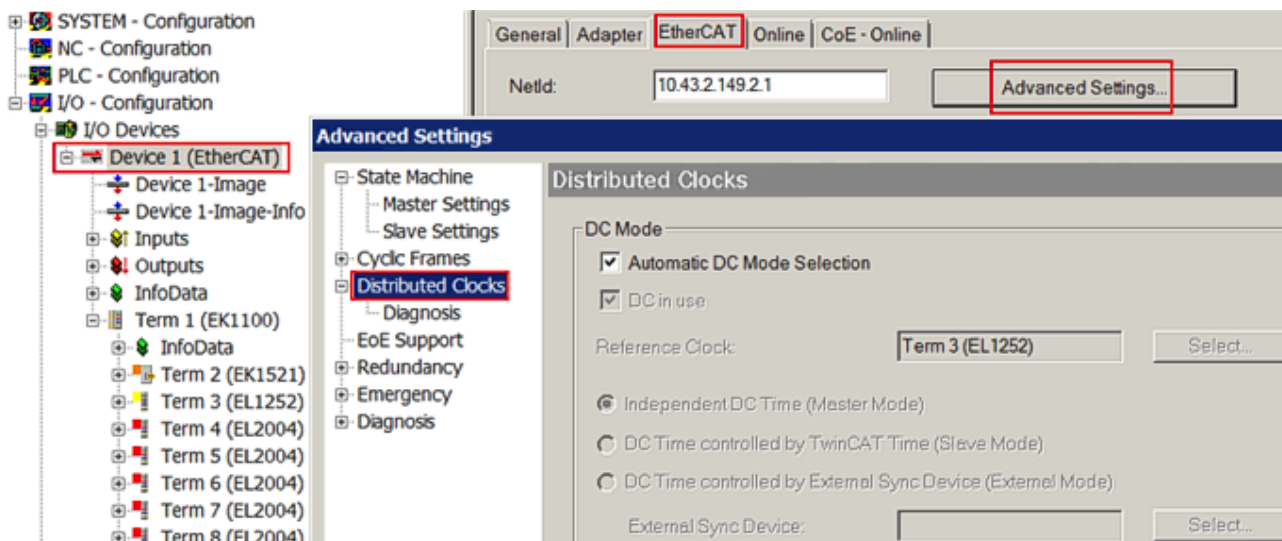

Fig. 27: Advanced Distributed Clocks settings in the EtherCAT master

The figure shows how TwinCAT selects the EL1252 as reference clock by default, since the preceding components do not support DC.

**Settings EtherCAT device**

System and infrastructure devices such as EK1100 or EK1122 couplers and junction etc. do not require Distributed Clocks to function properly. Nevertheless, it may be topologically expedient to designate the first coupler in an EtherCAT system as reference clock, for example. For this reason, from a certain level the infrastructure components are able to operate as reference clocks, based on special configuration settings.

According to the following table (*DC support from rev/firmware version*), the components support activation of distributed clocks:

Device	XML revision in the configuration	Serial number of the component
BK1150	from BK1150-0000-0016	from firmware 01: xxxx01yy
CU1128	from CU1128-0000-0000	from firmware 00: xxxx00yy
EK1100	from EK1100-0000-0017	from firmware 06: xxxx06yy
EK1101	from EK1101-0000-0017	from firmware 01: xxxx01yy
EK1501	from EK1501-0000-0017	from firmware 01: xxxx01yy
EK1501-0010	from EK1501-0010-0017	from firmware 02: xxxx02yy
EK1122	from EK1122-0000-0017	from firmware 01: xxxx02yy
EK1521	from EK1521-0000-0018	from firmware 03: xxxx03yy
EK1541	from EK1541-0000-0016	from firmware 01: xxxx01yy
EK1561	from EK1561-0000-0016	from firmware 01: xxxx01yy
EK1521-0010	from EK1521-0010-0018	from firmware 03: xxxx03yy
EK1814	from EK1814-0000-0016	from firmware 00: xxxx00yy

To ensure that TwinCAT uses such a component as DC reference clock, a manual intervention during the configuration setup is required, as shown here using the EK1100 as an example.

The checkboxes “Cyclic Mode Enable” and “Use as potential Reference Clock” must be set.



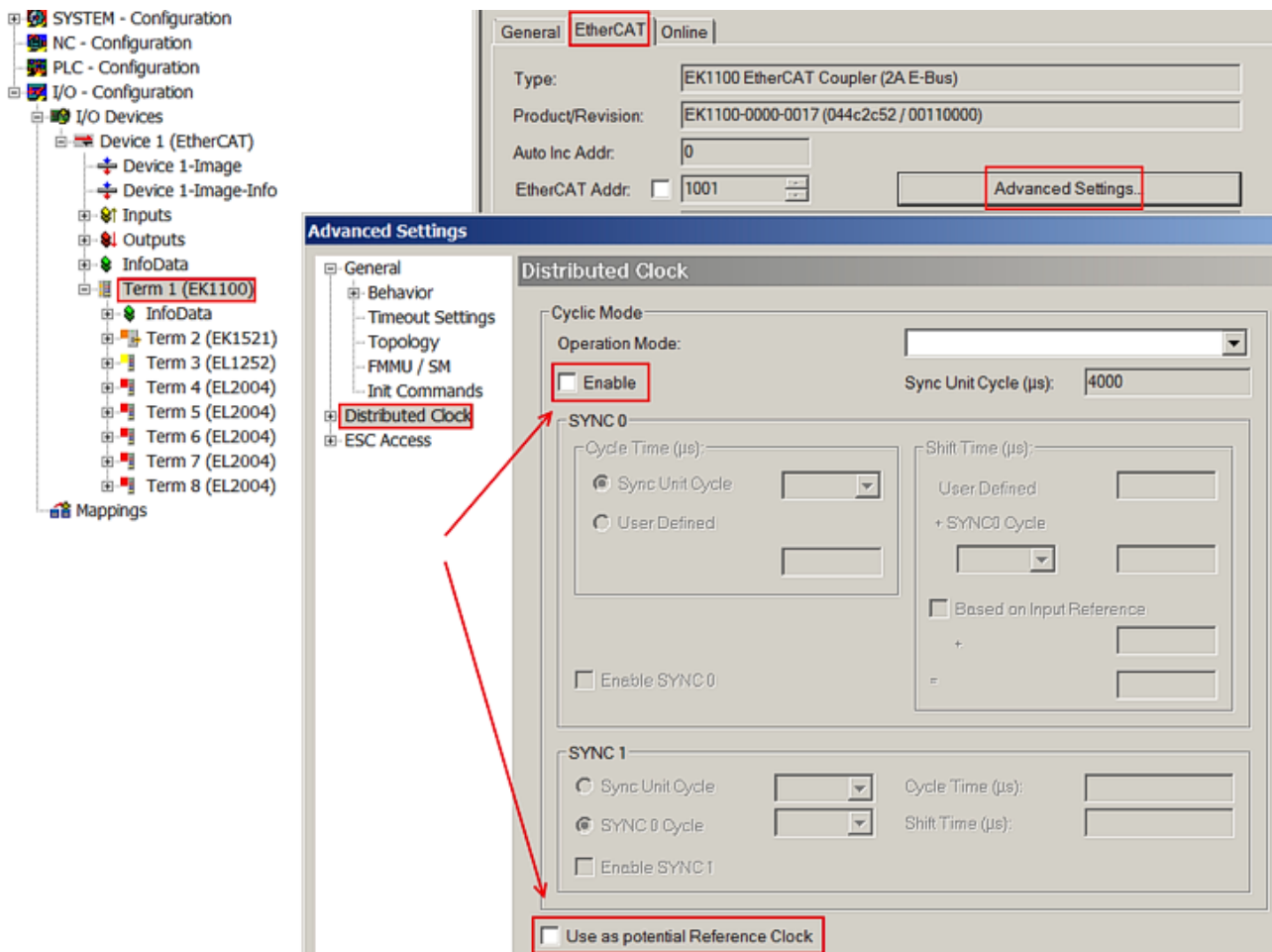

Fig. 28: TwinCAT setting for using this component as reference clock

## ● Activation of Distributed Clocks support

**i** The (synchronization) procedure described here is only successful for the components described above. The checkboxes can be set for other components, too, although the hardware does not support this function, unless specified in the respective documentation. In particular, please note that after commissioning the component may not be replaced with a previous version without DC support.

## 4 Mounting and wiring

### 4.1 Instructions for ESD protection

#### NOTICE

##### **Destruction of the devices by electrostatic discharge possible!**

The devices contain components at risk from electrostatic discharge caused by improper handling.

- Please ensure you are electrostatically discharged and avoid touching the contacts of the device directly.
- Avoid contact with highly insulating materials (synthetic fibers, plastic film etc.).
- Surroundings (working place, packaging and personnel) should be grounded probably, when handling with the devices.
- Each assembly must be terminated at the right hand end with an [EL9011](#) or [EL9012](#) bus end cap, to ensure the protection class and ESD protection.

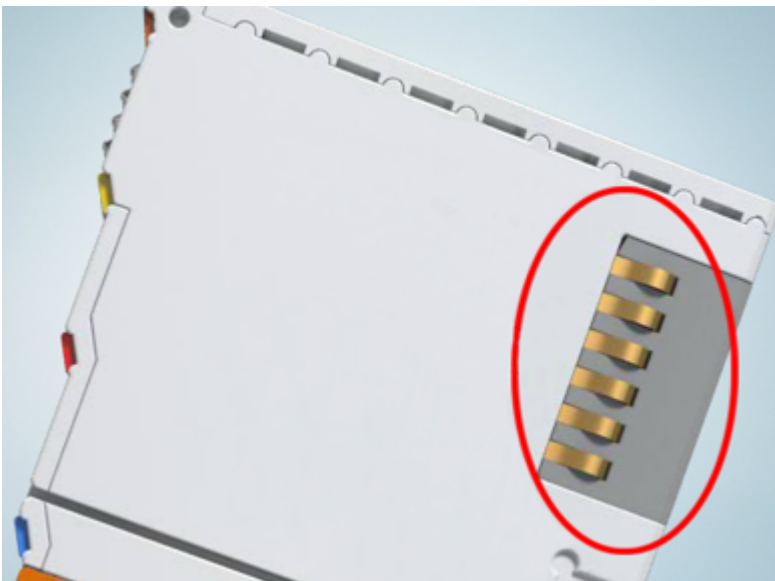

Fig. 29: Spring contacts of the Beckhoff I/O components

## 4.2 Explosion protection

### 4.2.1 ATEX - Special conditions (extended temperature range)

#### ⚠ WARNING

**Observe the special conditions for the intended use of Beckhoff fieldbus components with extended temperature range (ET) in potentially explosive areas (directive 2014/34/EU)!**

- The certified components are to be installed in a suitable housing that guarantees a protection class of at least IP54 in accordance with EN 60079-15! The environmental conditions during use are thereby to be taken into account!
- For dust (only the fieldbus components of certificate no. KEMA 10ATEX0075 X Issue 9): The equipment shall be installed in a suitable enclosure providing a degree of protection of IP54 according to EN 60079-31 for group IIIA or IIIB and IP6X for group IIIC, taking into account the environmental conditions under which the equipment is used!
- If the temperatures during rated operation are higher than 70°C at the feed-in points of cables, lines or pipes, or higher than 80°C at the wire branching points, then cables must be selected whose temperature data correspond to the actual measured temperature values!
- Observe the permissible ambient temperature range of -25 to 60°C for the use of Beckhoff fieldbus components with extended temperature range (ET) in potentially explosive areas!
- Measures must be taken to protect against the rated operating voltage being exceeded by more than 40% due to short-term interference voltages!
- The individual terminals may only be unplugged or removed from the Bus Terminal system if the supply voltage has been switched off or if a non-explosive atmosphere is ensured!
- The connections of the certified components may only be connected or disconnected if the supply voltage has been switched off or if a non-explosive atmosphere is ensured!
- The fuses of the KL92xx/EL92xx power feed terminals may only be exchanged if the supply voltage has been switched off or if a non-explosive atmosphere is ensured!
- Address selectors and ID switches may only be adjusted if the supply voltage has been switched off or if a non-explosive atmosphere is ensured!

#### Standards

The fundamental health and safety requirements are fulfilled by compliance with the following standards:

- EN 60079-0:2012+A11:2013
- EN 60079-15:2010
- EN 60079-31:2013 (only for certificate no. KEMA 10ATEX0075 X Issue 9)

#### Marking

The Beckhoff fieldbus components with extended temperature range (ET) certified according to the ATEX directive for potentially explosive areas bear the following marking:



**II 3G KEMA 10ATEX0075 X Ex nA IIC T4 Gc Ta: -25 ... +60°C**

II 3D KEMA 10ATEX0075 X Ex tc IIIC T135°C Dc Ta: -25 ... +60°C  
(only for fieldbus components of certificate no. KEMA 10ATEX0075 X Issue 9)

or



**II 3G KEMA 10ATEX0075 X Ex nA nC IIC T4 Gc Ta: -25 ... +60°C**

II 3D KEMA 10ATEX0075 X Ex tc IIIC T135°C Dc Ta: -25 ... +60°C  
(only for fieldbus components of certificate no. KEMA 10ATEX0075 X Issue 9)

## 4.2.2 IECEx - Special conditions

### WARNING

#### Observe the special conditions for the intended use of Beckhoff fieldbus components in potentially explosive areas!

- For gas: The equipment shall be installed in a suitable enclosure providing a degree of protection of IP54 according to IEC 60079-15, taking into account the environmental conditions under which the equipment is used!
- For dust (only the fieldbus components of certificate no. IECEx DEK 16.0078X Issue 3): The equipment shall be installed in a suitable enclosure providing a degree of protection of IP54 according to EN 60079-31 for group IIIA or IIIB and IP6X for group IIIC, taking into account the environmental conditions under which the equipment is used!
- The equipment shall only be used in an area of at least pollution degree 2, as defined in IEC 60664-1!
- Provisions shall be made to prevent the rated voltage from being exceeded by transient disturbances of more than 119 V!
- If the temperatures during rated operation are higher than 70°C at the feed-in points of cables, lines or pipes, or higher than 80°C at the wire branching points, then cables must be selected whose temperature data correspond to the actual measured temperature values!
- Observe the permissible ambient temperature range for the use of Beckhoff fieldbus components in potentially explosive areas!
- The individual terminals may only be unplugged or removed from the Bus Terminal system if the supply voltage has been switched off or if a non-explosive atmosphere is ensured!
- The connections of the certified components may only be connected or disconnected if the supply voltage has been switched off or if a non-explosive atmosphere is ensured!
- Address selectors and ID switches may only be adjusted if the supply voltage has been switched off or if a non-explosive atmosphere is ensured!
- The front hatch of certified units may only be opened if the supply voltage has been switched off or a non-explosive atmosphere is ensured!

### Standards

The fundamental health and safety requirements are fulfilled by compliance with the following standards:

- EN 60079-0:2011
- EN 60079-15:2010
- EN 60079-31:2013 (only for certificate no. IECEx DEK 16.0078X Issue 3)

### Marking

Beckhoff fieldbus components that are certified in accordance with IECEx for use in areas subject to an explosion hazard bear the following markings:

Marking for fieldbus components of certificate no. IECEx DEK 16.0078X Issue 3:	<b>IECEx DEK 16.0078 X</b>
	<b>Ex nA IIC T4 Gc</b>
	<b>Ex tc IIIC T135°C Dc</b>

Marking for fieldbus components of certificates with later issues:	<b>IECEx DEK 16.0078 X</b>
	<b>Ex nA IIC T4 Gc</b>

### 4.2.3 Continulative documentation for ATEX and IECEx

#### NOTICE



#### Continulative documentation about explosion protection according to ATEX and IECEx

Pay also attention to the continuative documentation

#### **Ex. Protection for Terminal Systems**

Notes on the use of the Beckhoff terminal systems in hazardous areas according to ATEX and IECEx,

that is available for [download](#) within the download area of your product on the Beckhoff homepage [www.beckhoff.com](http://www.beckhoff.com)!

## 4.2.4 cFMus - Special conditions

### WARNING

**Observe the special conditions for the intended use of Beckhoff fieldbus components in potentially explosive areas!**

- The equipment shall be installed within an enclosure that provides a minimum ingress protection of IP54 in accordance with ANSI/UL 60079-0 (US) or CSA C22.2 No. 60079-0 (Canada).
- The equipment shall only be used in an area of at least pollution degree 2, as defined in IEC 60664-1.
- Transient protection shall be provided that is set at a level not exceeding 140% of the peak rated voltage value at the supply terminals to the equipment.
- The circuits shall be limited to overvoltage Category II as defined in IEC 60664-1.
- The Fieldbus Components may only be removed or inserted when the system supply and the field supply are switched off, or when the location is known to be non-hazardous.
- The Fieldbus Components may only be disconnected or connected when the system supply is switched off, or when the location is known to be non-hazardous.

### Standards

The fundamental health and safety requirements are fulfilled by compliance with the following standards:

M20US0111X (US):

- FM Class 3600:2018
- FM Class 3611:2018
- FM Class 3810:2018
- ANSI/UL 121201:2019
- ANSI/ISA 61010-1:2012
- ANSI/UL 60079-0:2020
- ANSI/UL 60079-7:2017

FM20CA0053X (Canada):

- CAN/CSA C22.2 No. 213-17:2017
- CSA C22.2 No. 60079-0:2019
- CAN/CSA C22.2 No. 60079-7:2016
- CAN/CSA C22.2 No.61010-1:2012

### Marking

Beckhoff fieldbus components that are certified in accordance with cFMus for use in areas subject to an explosion hazard bear the following markings:

FM20US0111X (US):            **Class I, Division 2, Groups A, B, C, D**  
    **Class I, Zone 2, AEx ec IIC T4 Gc**

FM20CA0053X (Canada):    **Class I, Division 2, Groups A, B, C, D**  
    **Ex ec T4 Gc**

## 4.2.5 Continulative documentation for cFMus

### NOTICE



#### **Continulative documentation about explosion protection according to cFMus**



Pay also attention to the continuative documentation

#### **Control Drawing I/O, CX, CPX**

Connection diagrams and Ex markings,

that is available for download within the download area of your product on the Beckhoff homepage [www.beckhoff.com](http://www.beckhoff.com)!

### 4.3 UL notice

<b>⚠ CAUTION</b>	
	<p><b>Application</b> Beckhoff EtherCAT modules are intended for use with Beckhoff's UL Listed EtherCAT System only.</p>
<b>⚠ CAUTION</b>	
	<p><b>Examination</b> For cULus examination, the Beckhoff I/O System has only been investigated for risk of fire and electrical shock (in accordance with UL508 and CSA C22.2 No. 142).</p>
<b>⚠ CAUTION</b>	
	<p><b>For devices with Ethernet connectors</b> Not for connection to telecommunication circuits.</p>

#### Basic principles

UL certification according to UL508. Devices with this kind of certification are marked by this sign:





## 4.4 Installation on mounting rails

### ⚠ WARNING

#### Risk of electric shock and damage of device!

Bring the bus terminal system into a safe, powered down state before starting installation, disassembly or wiring of the bus terminals!

The Bus Terminal system and is designed for mounting in a control cabinet or terminal box.

#### Assembly

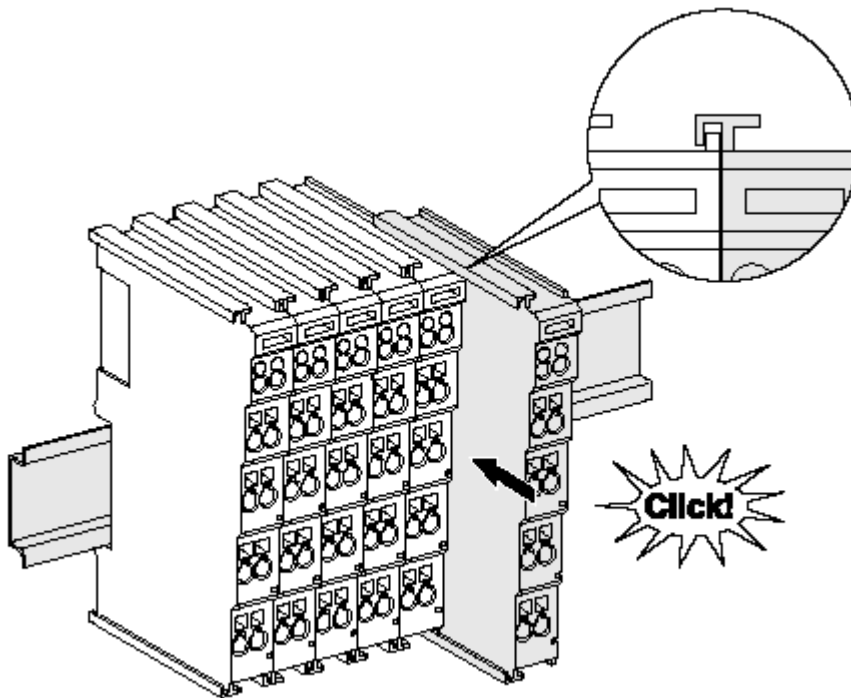

Fig. 30: Attaching on mounting rail

The bus coupler and bus terminals are attached to commercially available 35 mm mounting rails (DIN rails according to EN 60715) by applying slight pressure:

1. First attach the fieldbus coupler to the mounting rail.
2. The bus terminals are now attached on the right-hand side of the fieldbus coupler. Join the components with tongue and groove and push the terminals against the mounting rail, until the lock clicks onto the mounting rail.

If the terminals are clipped onto the mounting rail first and then pushed together without tongue and groove, the connection will not be operational! When correctly assembled, no significant gap should be visible between the housings.

#### **i** Fixing of mounting rails

The locking mechanism of the terminals and couplers extends to the profile of the mounting rail. At the installation, the locking mechanism of the components must not come into conflict with the fixing bolts of the mounting rail. To mount the mounting rails with a height of 7.5 mm under the terminals and couplers, you should use flat mounting connections (e.g. countersunk screws or blind rivets).

## Disassembly

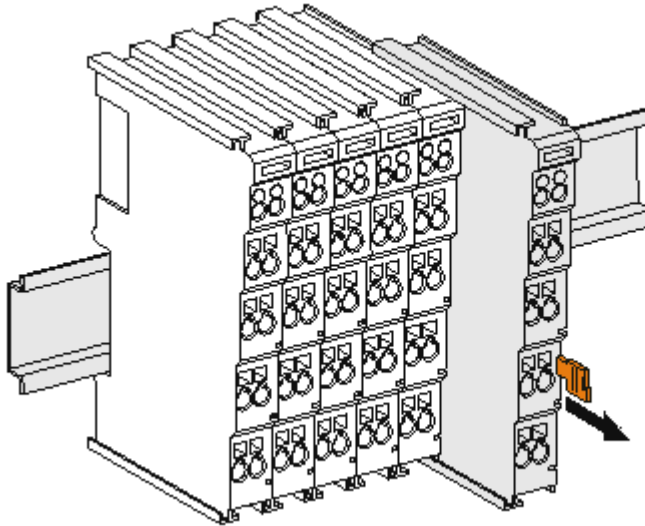

Fig. 31: Disassembling of terminal

Each terminal is secured by a lock on the mounting rail, which must be released for disassembly:

1. Pull the terminal by its orange-colored lugs approximately 1 cm away from the mounting rail. In doing so for this terminal the mounting rail lock is released automatically and you can pull the terminal out of the bus terminal block easily without excessive force.
2. Grasp the released terminal with thumb and index finger simultaneous at the upper and lower grooved housing surfaces and pull the terminal out of the bus terminal block.

## Connections within a bus terminal block

The electric connections between the Bus Coupler and the Bus Terminals are automatically realized by joining the components:

- The six spring contacts of the K-Bus/E-Bus deal with the transfer of the data and the supply of the Bus Terminal electronics.
- The power contacts deal with the supply for the field electronics and thus represent a supply rail within the bus terminal block. The power contacts are supplied via terminals on the Bus Coupler (up to 24 V) or for higher voltages via power feed terminals.

### ● Power Contacts

**i** During the design of a bus terminal block, the pin assignment of the individual Bus Terminals must be taken account of, since some types (e.g. analog Bus Terminals or digital 4-channel Bus Terminals) do not or not fully loop through the power contacts. Power Feed Terminals (KL91xx, KL92xx or EL91xx, EL92xx) interrupt the power contacts and thus represent the start of a new supply rail.

## PE power contact

The power contact labeled PE can be used as a protective earth. For safety reasons this contact mates first when plugging together, and can ground short-circuit currents of up to 125 A.

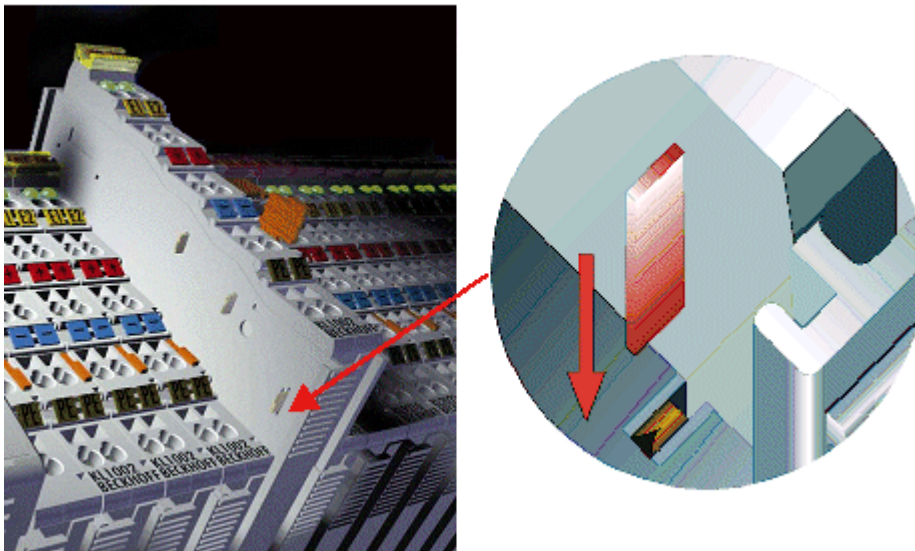

Fig. 32: Power contact on left side

### NOTICE

#### Possible damage of the device

Note that, for reasons of electromagnetic compatibility, the PE contacts are capacitatively coupled to the mounting rail. This may lead to incorrect results during insulation testing or to damage on the terminal (e.g. disruptive discharge to the PE line during insulation testing of a consumer with a nominal voltage of 230 V). For insulation testing, disconnect the PE supply line at the Bus Coupler or the Power Feed Terminal! In order to decouple further feed points for testing, these Power Feed Terminals can be released and pulled at least 10 mm from the group of terminals.

### ⚠ WARNING

#### Risk of electric shock!

The PE power contact must not be used for other potentials!

## 4.5 Installation instructions for enhanced mechanical load capacity

### ⚠ WARNING

#### Risk of injury through electric shock and damage to the device!

Bring the Bus Terminal system into a safe, de-energized state before starting mounting, disassembly or wiring of the Bus Terminals!

#### Additional checks

The terminals have undergone the following additional tests:

Verification	Explanation
Vibration	10 frequency runs in 3 axes
	6 Hz < f < 60 Hz displacement 0.35 mm, constant amplitude
	60.1 Hz < f < 500 Hz acceleration 5 g, constant amplitude
Shocks	1000 shocks in each direction, in 3 axes
	25 g, 6 ms

#### Additional installation instructions

For terminals with enhanced mechanical load capacity, the following additional installation instructions apply:

- The enhanced mechanical load capacity is valid for all permissible installation positions
- Use a mounting rail according to EN 60715 TH35-15
- Fix the terminal segment on both sides of the mounting rail with a mechanical fixture, e.g. an earth terminal or reinforced end clamp
- The maximum total extension of the terminal segment (without coupler) is:  
64 terminals (12 mm mounting with) or 32 terminals (24 mm mounting with)
- Avoid deformation, twisting, crushing and bending of the mounting rail during edging and installation of the rail
- The mounting points of the mounting rail must be set at 5 cm intervals
- Use countersunk head screws to fasten the mounting rail
- The free length between the strain relief and the wire connection should be kept as short as possible. A distance of approx. 10 cm should be maintained to the cable duct.

## 4.6 Installation positions

### NOTICE

#### Constraints regarding installation position and operating temperature range

Please refer to the technical data for a terminal to ascertain whether any restrictions regarding the installation position and/or the operating temperature range have been specified. When installing high power dissipation terminals ensure that an adequate spacing is maintained between other components above and below the terminal in order to guarantee adequate ventilation!

#### Optimum installation position (standard)

The optimum installation position requires the mounting rail to be installed horizontally and the connection surfaces of the EL/KL terminals to face forward (see Fig. *Recommended distances for standard installation position*). The terminals are ventilated from below, which enables optimum cooling of the electronics through convection. "From below" is relative to the acceleration of gravity.

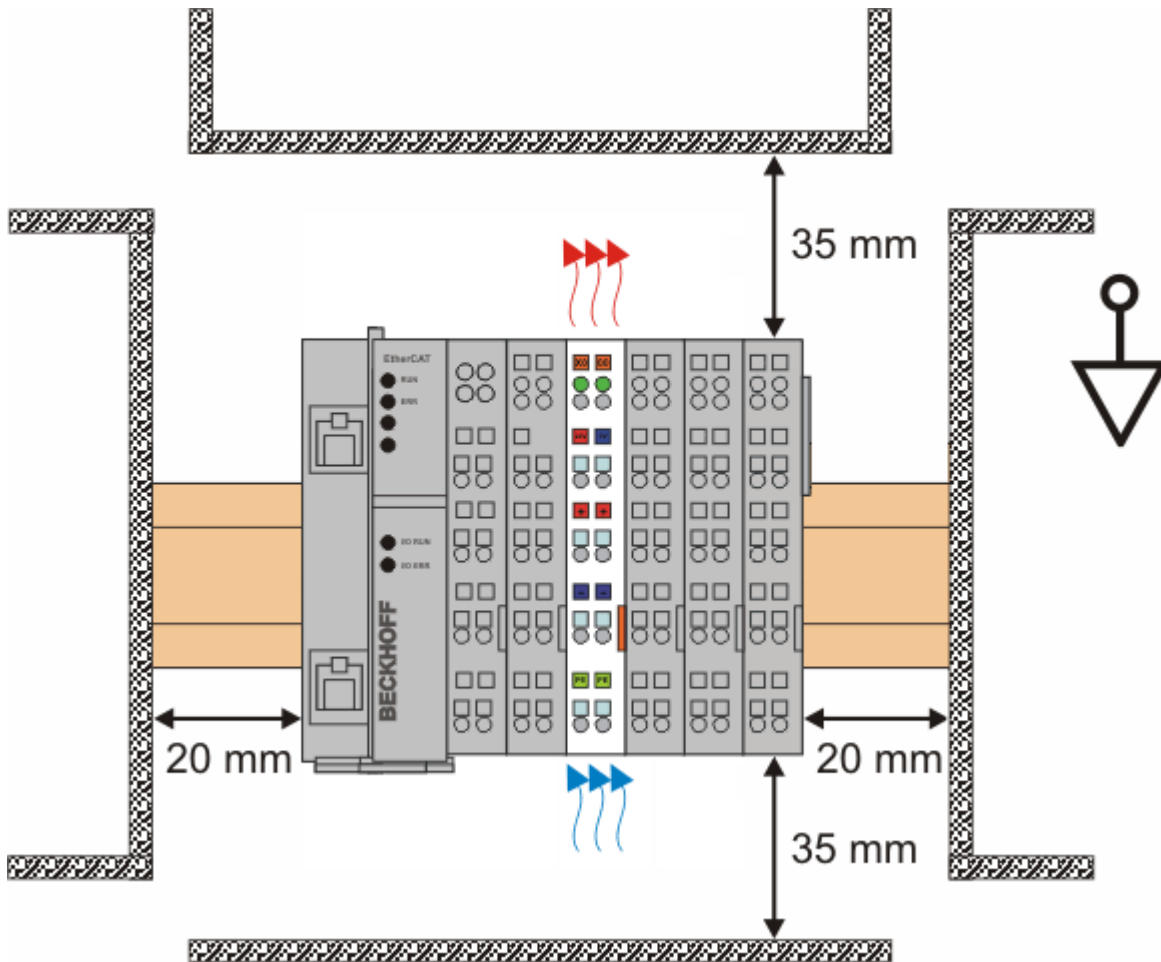

Fig. 33: Recommended distances for standard installation position

Compliance with the distances shown in Fig. *Recommended distances for standard installation position* is recommended.

#### Other installation positions

All other installation positions are characterized by different spatial arrangement of the mounting rail - see Fig *Other installation positions*.

The minimum distances to ambient specified above also apply to these installation positions.

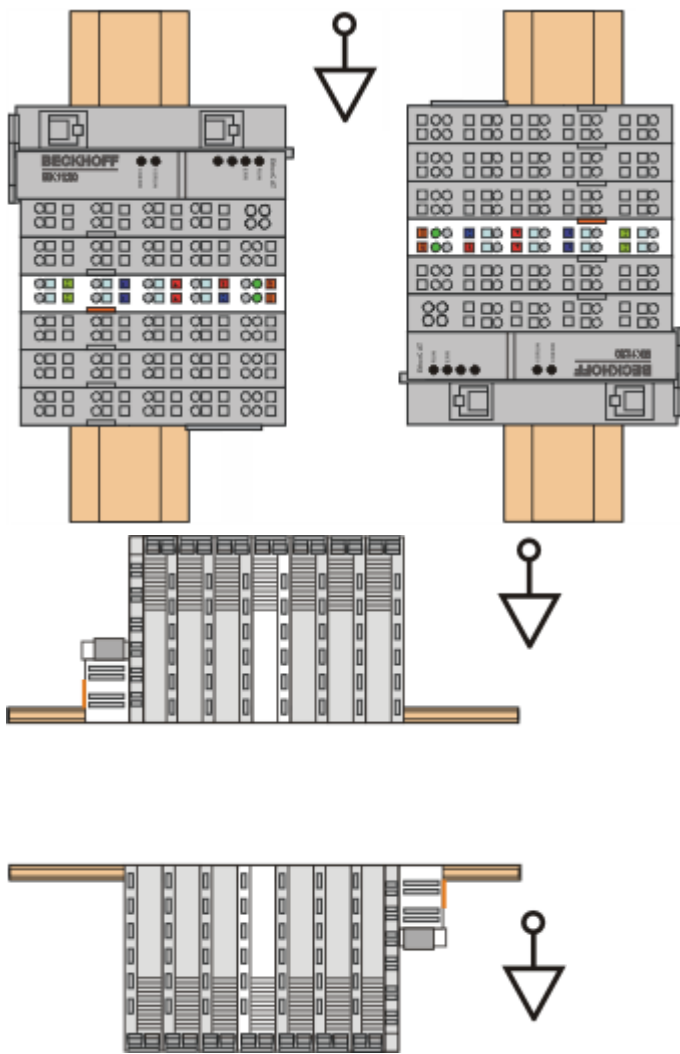

Fig. 34: Other installation positions

## 4.7 Connection system

### ⚠ WARNING

#### Risk of electric shock and damage of device!

Bring the bus terminal system into a safe, powered down state before starting installation, disassembly or wiring of the bus terminals!

#### Overview

The bus terminal system offers different connection options for optimum adaptation to the respective application:

- The terminals of ELxxxx and KLxxxx series with standard wiring include electronics and connection level in a single enclosure.
- The terminals of ESxxxx and KSxxxx series feature a pluggable connection level and enable steady wiring while replacing.
- The High Density Terminals (HD Terminals) include electronics and connection level in a single enclosure and have advanced packaging density.

#### Standard wiring (ELxxxx / KLxxxx)



Fig. 35: Standard wiring

The terminals of ELxxxx and KLxxxx series have been tried and tested for years. They feature integrated screwless spring force technology for fast and simple assembly.

#### Pluggable wiring (ESxxxx / KSxxxx)



Fig. 36: Pluggable wiring

The terminals of ESxxxx and KSxxxx series feature a pluggable connection level. The assembly and wiring procedure is the same as for the ELxxxx and KLxxxx series. The pluggable connection level enables the complete wiring to be removed as a plug connector from the top of the housing for servicing. The lower section can be removed from the terminal block by pulling the unlocking tab. Insert the new component and plug in the connector with the wiring. This reduces the installation time and eliminates the risk of wires being mixed up.

The familiar dimensions of the terminal only had to be changed slightly. The new connector adds about 3 mm. The maximum height of the terminal remains unchanged.

A tab for strain relief of the cable simplifies assembly in many applications and prevents tangling of individual connection wires when the connector is removed.

Conductor cross sections between 0.08 mm<sup>2</sup> and 2.5 mm<sup>2</sup> can continue to be used with the proven spring force technology.

The overview and nomenclature of the product names for ESxxxx and KSxxxx series has been retained as known from ELxxxx and KLxxxx series.

### High Density Terminals (HD Terminals)



Fig. 37: High Density Terminals

The terminals from these series with 16 terminal points are distinguished by a particularly compact design, as the packaging density is twice as large as that of the standard 12 mm bus terminals. Massive conductors and conductors with a wire end sleeve can be inserted directly into the spring loaded terminal point without tools.

---

#### ● **Wiring HD Terminals**

**i** The High Density Terminals of the ELx8xx and KLx8xx series doesn't support pluggable wiring.

---

### Ultrasonically “bonded” (ultrasonically welded) conductors

---

#### ● **Ultrasonically “bonded” conductors**

**i** It is also possible to connect the Standard and High Density Terminals with ultrasonically “bonded” (ultrasonically welded) conductors. In this case, please note the tables concerning the wire-size width [[▶ 65](#)]!

---



## 4.8 Wiring

**⚠ WARNING**

**Risk of electric shock and damage of device!**

Bring the bus terminal system into a safe, powered down state before starting installation, disassembly or wiring of the bus terminals!

**Terminals for standard wiring ELxxxx/KLxxxx and for pluggable wiring ESxxxx/KSxxxx**

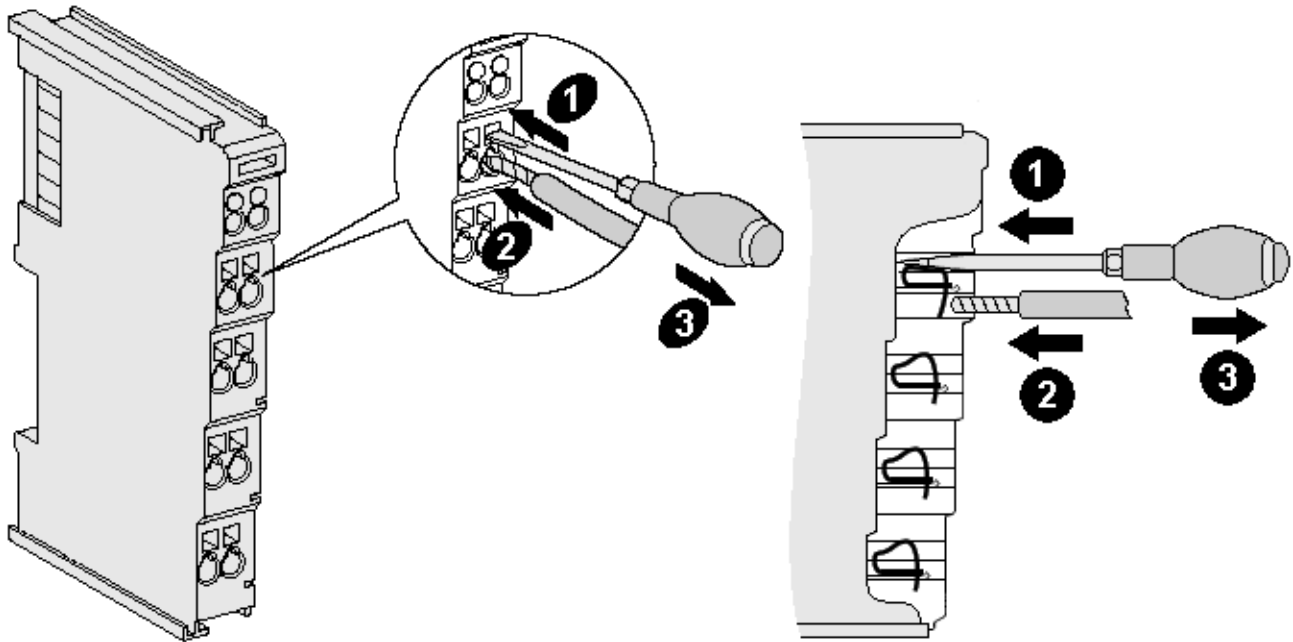

Fig. 38: Connecting a cable on a terminal point

Up to eight terminal points enable the connection of solid or finely stranded cables to the bus terminal. The terminal points are implemented in spring force technology. Connect the cables as follows:

1. Open a terminal point by pushing a screwdriver straight against the stop into the square opening above the terminal point. Do not turn the screwdriver or move it alternately (don't toggle).
2. The wire can now be inserted into the round terminal opening without any force.
3. The terminal point closes automatically when the pressure is released, holding the wire securely and permanently.

See the following table for the suitable wire size width.

Terminal housing	ELxxxx, KLxxxx	ESxxxx, KSxxxx
Wire size width (single core wires)	0.08 ... 2.5 mm <sup>2</sup>	0.08 ... 2.5 mm <sup>2</sup>
Wire size width (fine-wire conductors)	0.08 ... 2.5 mm <sup>2</sup>	0.08 ... 2.5 mm <sup>2</sup>
Wire size width (conductors with a wire end sleeve)	0.14 ... 1.5 mm <sup>2</sup>	0.14 ... 1.5 mm <sup>2</sup>
Wire stripping length	8 ... 9 mm	9 ... 10 mm

**High Density Terminals (HD Terminals [▶ 64]) with 16 terminal points**

The conductors of the HD Terminals are connected without tools for single-wire conductors using the direct plug-in technique, i.e. after stripping the wire is simply plugged into the terminal point. The cables are released, as usual, using the contact release with the aid of a screwdriver. See the following table for the suitable wire size width.

<b>Terminal housing</b>	<b>High Density Housing</b>
<b>Wire size width (single core wires)</b>	0.08 ... 1.5 mm <sup>2</sup>
<b>Wire size width (fine-wire conductors)</b>	0.25 ... 1.5 mm <sup>2</sup>
<b>Wire size width (conductors with a wire end sleeve)</b>	0.14 ... 0.75 mm <sup>2</sup>
<b>Wire size width (ultrasonically "bonded" conductors)</b>	only 1.5 mm <sup>2</sup> (see notice [▶ 64])
<b>Wire stripping length</b>	8 ... 9 mm

## 4.9 EtherCAT cabling – wire-bound

The cable length between two EtherCAT devices must not exceed 100 m. This results from the FastEthernet technology, which, above all for reasons of signal attenuation over the length of the cable, allows a maximum link length of 5 + 90 + 5 m if cables with appropriate properties are used. See also the [Design recommendations for the infrastructure for EtherCAT/Ethernet](#).

### Cables and connectors

For connecting EtherCAT devices only Ethernet connections (cables + plugs) that meet the requirements of at least category 5 (CAT5) according to EN 50173 or ISO/IEC 11801 should be used. EtherCAT uses 4 wires for signal transfer.

EtherCAT uses RJ45 plug connectors, for example. The pin assignment is compatible with the Ethernet standard (ISO/IEC 8802-3).

Pin	Color of conductor	Signal	Description
1	yellow	TD +	Transmission Data +
2	orange	TD -	Transmission Data -
3	white	RD +	Receiver Data +
6	blue	RD -	Receiver Data -

Due to automatic cable detection (auto-crossing) symmetric (1:1) or cross-over cables can be used between EtherCAT devices from Beckhoff.

### Recommended cables

- i** It is recommended to use the appropriate Beckhoff components e.g.
- cable sets ZK1090-9191-xxxx respectively
  - RJ45 connector, field assembly ZS1090-0005
  - EtherCAT cable, field assembly ZB9010, ZB9020

Suitable cables for the connection of EtherCAT devices can be found on the [Beckhoff website!](#)

### E-Bus supply

A bus coupler can supply the EL terminals added to it with the E-bus system voltage of 5 V; a coupler is thereby loadable up to 2 A as a rule (see details in respective device documentation). Information on how much current each EL terminal requires from the E-bus supply is available online and in the catalogue. If the added terminals require more current than the coupler can supply, then power feed terminals (e.g. [EL9410](#)) must be inserted at appropriate places in the terminal strand.

The pre-calculated theoretical maximum E-Bus current is displayed in the TwinCAT System Manager. A shortfall is marked by a negative total amount and an exclamation mark; a power feed terminal is to be placed before such a position.

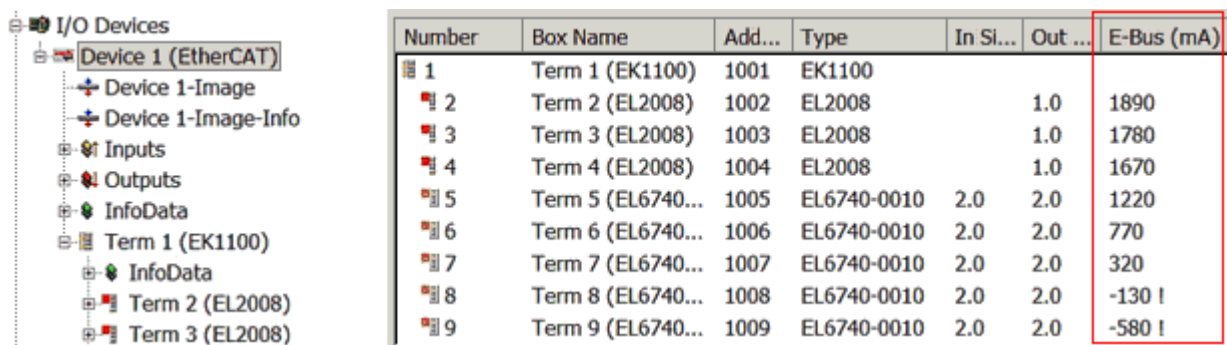

Fig. 39: System manager current calculation

**NOTICE**

**Malfunction possible!**

The same ground potential must be used for the E-Bus supply of all EtherCAT terminals in a terminal block!

## 4.10 M8 Connector Cabling

A list of the EtherCAT cable, power cable, sensor cable, Ethernet-/EtherCAT connectors and the field assembled connectors can be found at the following link: <https://www.beckhoff.com/en-us/products/i-o/accessories/>

You can find the corresponding data sheets at the following link: <https://www.beckhoff.com/en-us/support/download-finder/data-sheets/>

### EtherCAT cable



Fig. 40: ZK1090-3131-0xxx

For connecting EtherCAT devices only shielded Ethernet cables that meet the requirements of at least **category 5 (CAT5) according to EN 50173 or ISO/IEC 11801** should be used.

#### **i** Recommendations about cabling

You may get detailed recommendations about cabling EtherCAT from the documentation "Recommendations for the design of the infrastructure for EtherCAT/Ethernet", that is available for download at [www.Beckhoff.com](http://www.Beckhoff.com).

EtherCAT uses 4 wires for signal transfer.

Due to automatic cable detection (auto-crossing) symmetric (1:1) or cross-over cables can be used between EtherCAT devices from Beckhoff.

### M8 Connector pin assignment



<b>Signal</b>	<b>Description</b>	<b>Pin (M8)</b>
Tx+	Transmit Data+	1
Tx-	Transmit Data-	4
Rx+	Receive Data+	2
Rx-	Receive Data-	3
Shield	Shielding	Housing

### 4.11 Nut torque for connectors



Fig. 41: X1 and X2 of EK1100-0008

For usage of the EtherCAT connectors M8 of EK1100-0008 the following have to be noticed:

#### M8 connectors

It is recommended to pull the M8 connectors tight with a nut torque of **0.4 Nm**. When using the torque control screwdriver [ZB8800](#) is also a max. torque of **0.5 Nm** permissible.

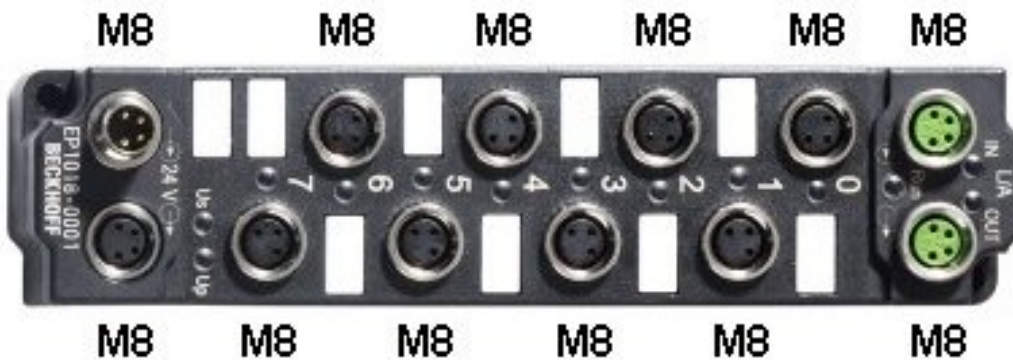

Fig. 42: EtherCAT Box with M8 connectors

## 4.12 Note - Power supply

### ⚠ WARNING

#### Power supply from SELV/PELV power supply unit!

SELV/PELV circuits (Safety Extra Low Voltage, Protective Extra Low Voltage) according to IEC 61010-2-201 must be used to supply this device.

Notes:

- SELV/PELV circuits may give rise to further requirements from standards such as IEC 60204-1 et al, for example with regard to cable spacing and insulation.
- A SELV (Safety Extra Low Voltage) supply provides safe electrical isolation and limitation of the voltage without a connection to the protective conductor, a PELV (Protective Extra Low Voltage) supply also requires a safe connection to the protective conductor.

## 4.13 Power supply, potential groups

### Bus Coupler power supply

The Bus Couplers require a 24 V<sub>DC</sub> supply for their operation. The connection is made by means of the upper spring-loaded terminals labelled 24 V and 0 V. The supply voltage is used by the Bus Coupler electronics and for direct voltage generation for the E-bus. The voltage generation for the E-bus takes place in a DC/DC converter without electrical isolation.

The EK1xxx units supply the E-bus with max. 2,000 mA E-bus current. Power feed terminals are to be inserted if the added terminals require more current.

### Input for power contacts

The bottom six connections with spring-loaded terminals can be used to feed the supply for the peripherals. The spring-loaded terminals are joined in pairs to a power contact. The feed for the power contacts has no connection to the voltage supply for the Bus Coupler. The design of the feed permits voltages of up to 24 V. The assignment in pairs and the electrical connection between feed terminal contacts allows the connection wires to be looped through to various terminal points. The current load via the power contacts may not permanently exceed 10 A; the supply line must therefore be protected by a 10 A fuse (slow-blow).

### Power contacts

On the right hand face of the Bus Coupler there are three spring contacts for the power contact connections. The spring contacts are hidden in slots so that they can not be accidentally touched. By attaching a Bus Terminal the blade contacts on the left hand side of the Bus Terminal are connected to the spring contacts. The tongue and groove guides on the top and bottom of the Bus Coupler and of the Bus Terminals guarantees that the power contacts mate securely.

The current load of the power contacts may not permanently exceed 10 A.

### Electrical isolation

The bus couplers operate by means of three independent potential groups. The supply voltage feeds the E-bus electronics in the bus coupler and the E-bus itself, which are electrically isolated. The supply voltage is also used to generate the operating voltage for the fieldbus.

Note: All the Bus Terminals are electrically isolated from the E-bus. The E-bus is thus electrically isolated from everything else.



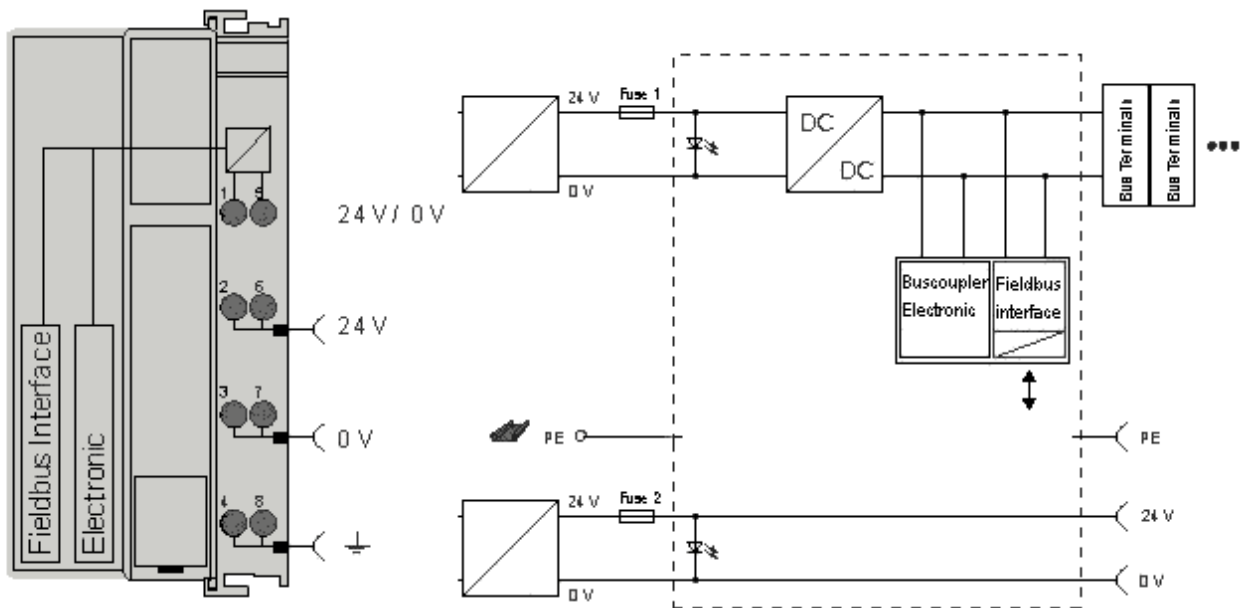

Fig. 43: Potential diagram EKxxxx

**GND concept**

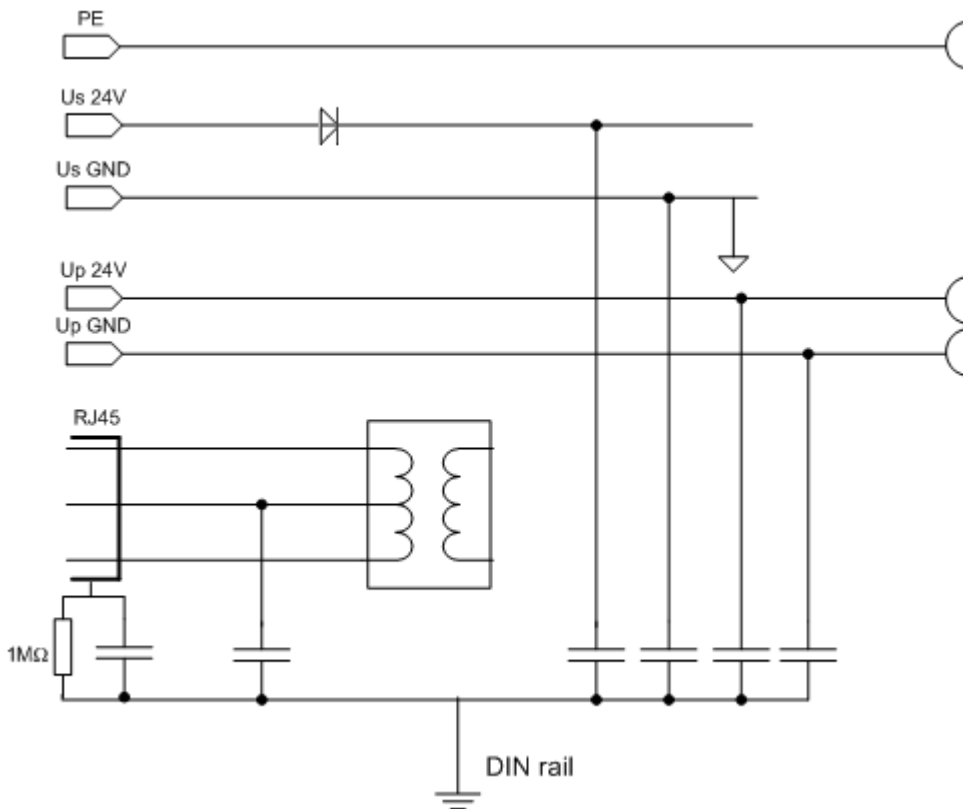

Fig. 44: GND concept EKxxxx

**Fuse protection**

**Coupler supply, fuse 1:**

depending on the required current consumption and hence the configured terminals  
typical max. 1 A

**Power contacts, fuse 2:**

permitted max. 10 A (slow-blow)

The coupler electronics and the power contacts can be supplied together from the same source. In this case the fuse should be dimensioned for 10 A max.

## 4.14 Positioning of passive Terminals

**i** **Hint for positioning of passive terminals in the bus terminal block**

EtherCAT Terminals (ELxxxx / ESxxxx), which do not take an active part in data transfer within the bus terminal block are so called passive terminals. The passive terminals have no current consumption out of the E-Bus.

To ensure an optimal data transfer, you must not directly string together more than two passive terminals!

**Examples for positioning of passive terminals (highlighted)**

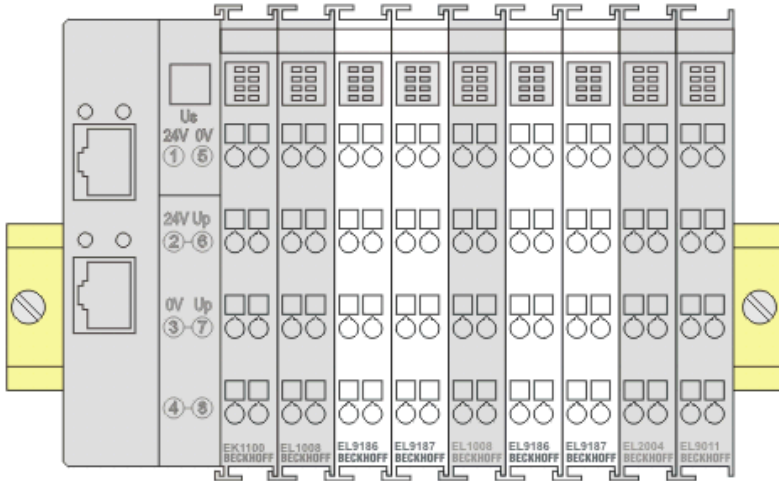

Fig. 45: Correct positioning

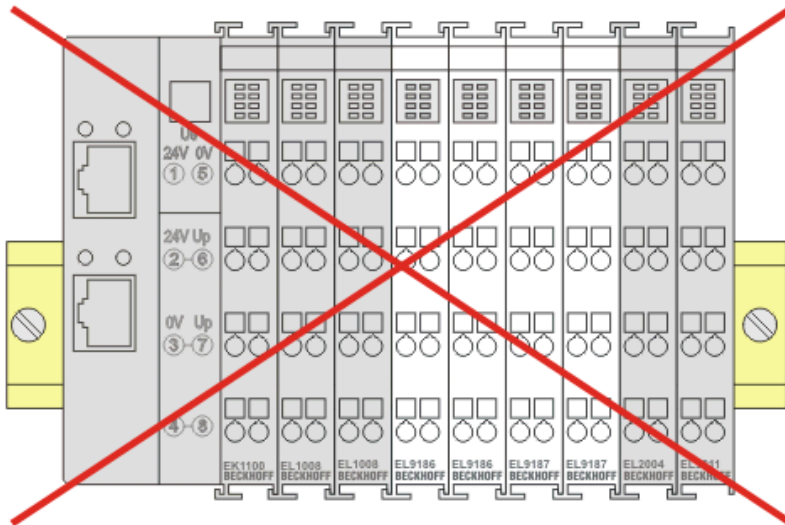

Fig. 46: Incorrect positioning

## 4.15 Disposal



Products marked with a crossed-out wheeled bin shall not be discarded with the normal waste stream. The device is considered as waste electrical and electronic equipment. The national regulations for the disposal of waste electrical and electronic equipment must be observed.

## **5 Commissioning/application notes**

### **5.1 Configuration overview**

More detailed information on the configuration settings can be found in the [EtherCAT System Documentation](#) on the Beckhoff website.

## 5.2 Notes for couplers with fiber-optic connection

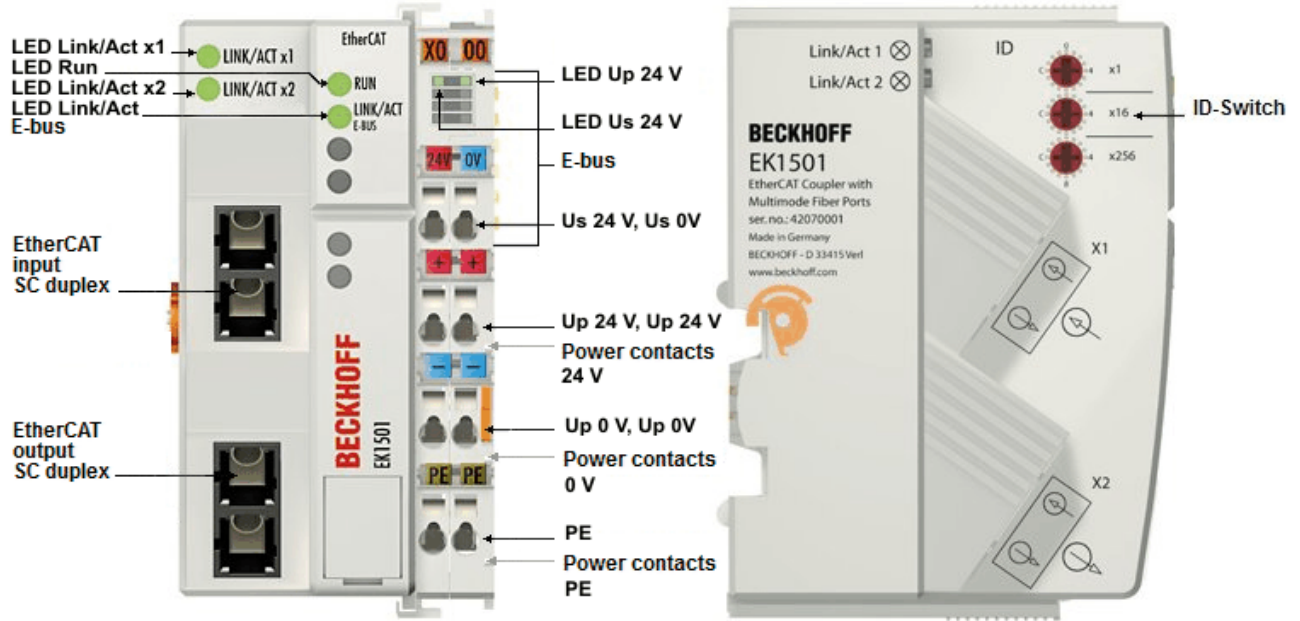

Fig. 47: EK1501

## 5.2.1 Principles of fiber-optic technology

When using fiber-optic cables for the transmission of data, there are various factors that influence the signal transmission and have to be observed in order to guarantee reliable transmission. Important principles of fiber-optic technology are described below.

### Attenuation

Less light reaches the end of a connection with fiber-optic cables than is input at the start of the connection. This loss of light between the start and end of the transmission link is called attenuation. The attenuation between two points is often stated in decibels (dB). However, the decibel is not a unit, but a ratio – in the case of a fiber-optic cable it is the ratio of the light energy at the start of the connection to that at the end. It is one tenth of a Bel (B) (1 B = 10 dB). In general, decibel indicates a power level  $L_p$  from the ratio of one power  $P_1$  to another power  $P_2$ .

- $L_p[\text{dB}] = 10 \cdot \log_{10}(P_1/P_2)$

A positive power factor is a signal amplification, a negative power factor conversely a weakening or attenuation of the signal.

The attenuation of a fiber-optic connection is essentially determined by three influencing factors. These influencing factors are the attenuation in the fiber-optic, the attenuation in the connector and the attenuations that result from the splices in the fiber-optic connection. The total attenuation is therefore given by

- Fiber-optic link attenuation [dB] = fiber loss attenuation [dB] + connector insertion attenuation [dB] + splice insertion attenuation [dB]

Where

- fiber loss attenuation [dB] = fiber attenuation coefficient [dB/km] x length [km]
- connector insertion attenuation [dB] = number of connectors x connector insertion attenuation [dB]
- splice insertion attenuation [dB] = number of splices x splice insertion attenuation [dB]

### Dispersion

A further influence that needs to be observed with the signal transmission is the dispersion. Dispersion describes the spreading or widening of a light pulse. Due to propagation differences resulting in the fiber-optic cable from different injection angles of the light waves, the optical pulse widens and is therefore wider at the output than at the input. The longer the transmission link, the greater the dispersion.

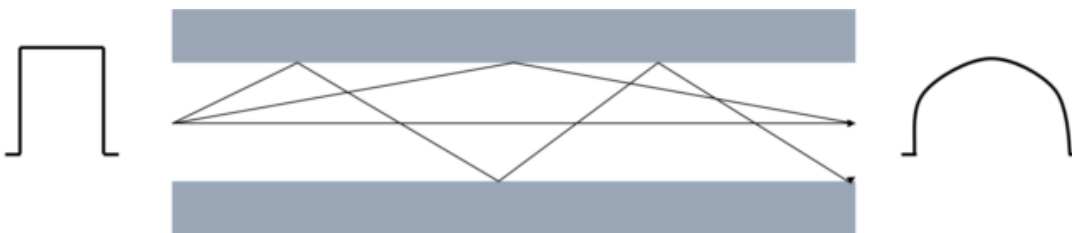

Fig. 48: Dispersion

If higher data rates are to be transmitted by the fiber-optic cable, the pulses must be sent faster at the input. What may happen then, however, is that pulses at the output run into one another and can no longer be distinguished from one another. The dispersion thus limits the maximum bandwidth of the fiber-optic connection.

The maximum bandwidth is specified in the data sheet for a fiber-optic cable as the bandwidth/length ratio in the unit MHz\*km. Therefore, the longer a transmission link, the smaller the available bandwidth. The bandwidth/length ratio or product is always specified in the data sheet for a fiber-optic cable. The length of the transmission link can then be calculated with the necessary bandwidth.

$$s [\text{km}] = \text{bandwidth} [\text{MHz}] / \text{bandwidth/length ratio} [\text{MHz/km}]$$

### Further influences on the signal transmission

In addition to the main influences (attenuation and dispersion) that limit the transmission link, care must be taken when installing and maintaining fiber-optic transmission links.

Sharp kinks and micro-bends in the fiber-optic lead to additional reflections in the fiber, as a result of which the influences of the attenuation and dispersion are increased. The specified bending radii of fiber-optic cables must be adhered to.

Poorly installed connectors also have a great influence on the signal quality. In case of poor connections, the fiber-optic may be too far away from the connecting piece, so that the light waves do not enter the fiber at the right angle of entry.

The third influence on the signal transmission that needs to be observed is soiling of, or damage to the ends of optical fibers. Due to the size of the fibers, often just 125 µm, dirt or damage cannot be discerned with the naked eye. Only a microscope with a sufficient magnification (at least factor 100) enables the fiber ends to be checked. To prevent soiling, the cable cap supplied with the cable should always be fitted to the fiber end.

### Power and attenuation budget

The power budget specifies the minimum power present between transmitter and receiver. The attenuation budget, conversely, describes the attenuation present between transmitter and receiver due to the three attenuation influences - fiber, connectors and splices - described above.

Transceivers (from the words transmitter and receiver) are installed in fiber-optic transmitters and/or receivers. This transceiver is a combined transmitting and receiving device. The data sheet for the transceiver contains two values that are necessary for the calculation of the power budget. These values are the **minimum output power** of the transmitter and the **maximum sensitivity** of the receiver. Therefore, the worst case, i.e. the lowest power between transmitter and receiver, is always considered. Both values are often specified in the unit decibel milliwatt (dBm). dBm describes a power level in relation to a reference value of 1 mW.

- $L_p[\text{dB}] = 10 \cdot \log_{10}(P_1/1 \text{ mW})$

0 dBm then corresponds to a power value of 1 mW, positive dBm values indicate power values >1 mW and negative dBm values indicate power values <1 mW.

The difference between the maximum output power and the minimum sensitivity at the input results in the power level.

- Power level = minimum output power - maximum sensitivity

The attenuation level results from the influences on the attenuation described above.

- Attenuation level [dB] = fiber loss attenuation [dB] + connector insertion attenuation [dB] + splice insertion attenuation [dB]



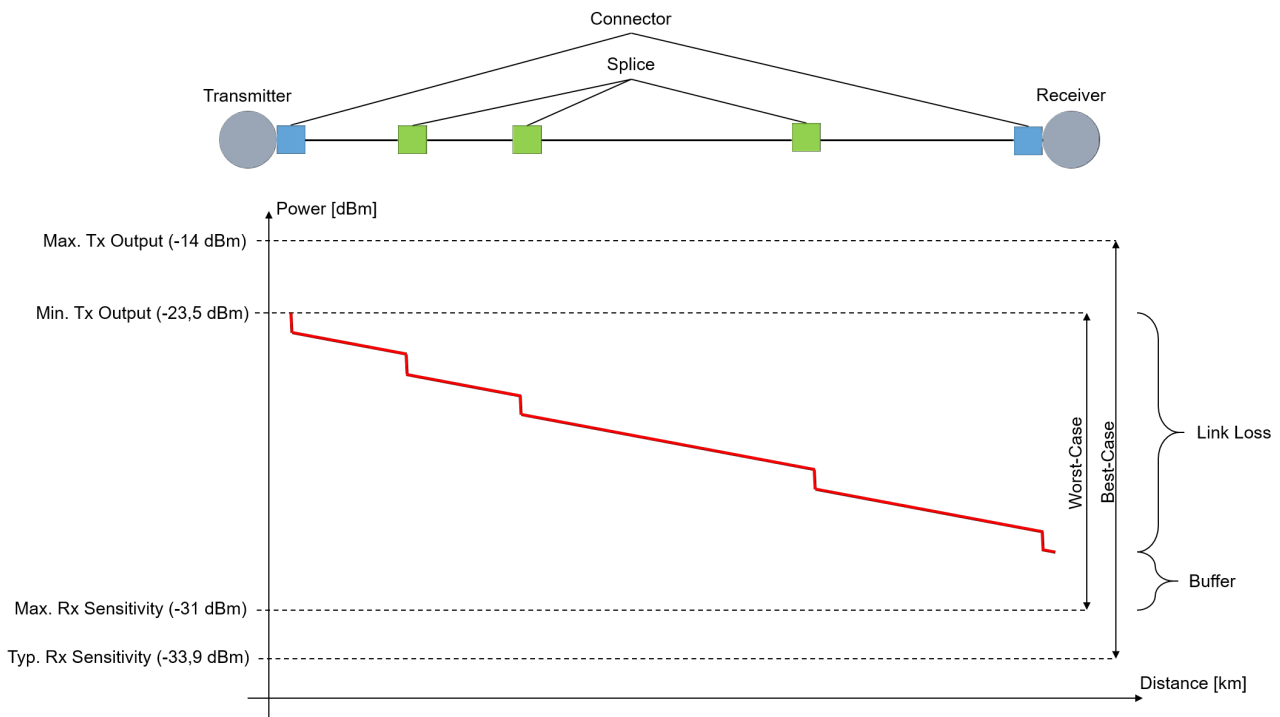

Fig. 49: Power and attenuation budget

The attenuation level must not exceed the power level. A power buffer of >3 dB is recommended so that long-term operation is possible over many years despite power losses. Sources located in the transmitter can age and lose power, connectors or splices can deteriorate, or connectors can become dirty if they are opened for diverting or testing. If cables are inadvertently cut through, excess play is required in order to accommodate splices for reconnecting.

**Example calculation of power and attenuation budget**

In an example calculation, the power and attenuation budget is to be calculated for a transmission link of 2.1 km in length between an EK1501 and an EK1521 with a multimode fiber in the strength 50/125 μm. The two fiber-optic couplers under consideration have the same transceiver. The optical data are given in the technical data for the EK1521.

First of all, the power budget existing between the two couplers must be calculated:

Power budget	
Parameter	Value
Minimum output power [50/125 μm]	-23.5 dBm
Maximum sensitivity	-31 dBm
<b>Power budget</b>	<b>7.5 dBm</b>

In the next step, the attenuation budget, i.e. the attenuation over the entire transmission link, must be calculated. A multimode fiber in the strength 50/125 μm from Beckhoff (ZK1091-1001-xxxx) is used for this example. A maximum attenuation of 0.8 dB/km at a wavelength of 1300 nm is specified in the data sheet for the fiber-optic cable. The cable is connected at both ends via an SC connector. The typical attenuation value of SC connectors is 0.25 dB, but it should nevertheless be checked for the specific application. Three splices were made over the entire link. A typical attenuation of 0.3 dB can be assumed per splice connection; however, the attenuation of a splice is dependent on its quality. The attenuation budget must be calculated from these values in the following.

<b>Attenuation budget</b>		
<b>Parameter</b>	<b>Number</b>	<b>Value</b>
Fiber loss attenuation (0.8 dB/km)	2.1 km	1.68 dB
Connector insertion attenuation (0.25 dB)	2	0.5 dB
Splice insertion attenuation (0.3 dB)	3	0.9 dB
<b>Attenuation budget</b>		<b>3.08 dB</b>

If the attenuation budget is now subtracted from the power budget, a power buffer of 4.42 dB results. This is greater than 3 dB and is therefore sufficient as a buffer for most applications, so that an additional splice or slight soiling of the fiber would not lead to failure of the data transmission.

If several values are given for a parameter in the data sheet for transceivers, cables or connectors, the worst value should always be taken and used for the calculation.

For the transmission link under consideration, the bandwidth/length ratio specified in the data sheet for the fiber should always be considered in addition to the attenuation and, as shown above, one should calculate whether the implementation of the length of the transmission link is possible with the desired bandwidth and the fiber.

**Evaluation of a fiber-optic transmission link by means of measurement**

A fiber-optic transmission link can be described and evaluated with parameters from data sheets. In order to obtain a real result for the attenuation over the entire link, however, the link must be measured using an optical power meter (OPM). The power at the end of the transmission link can be measured with an OPM.

When measuring with an OPM, it is essential to ensure that only the required adapter (FC, SC, ...) is screwed to the OPM. If several adapters are screwed above one another to the OPM, the distance between the connector and the detector in the OPM is too large, with the result that lower power values are displayed (greater attenuation than actually exists).



OPM without adapter



OPM with FC adapter screwed on



OPM with SC adapter screwed on



OPM with FC and SC adapter screwed on - WRONG

## 5.2.2 Notes on suitable optical fiber cables

### General information on optical fiber types

Optical fiber are available as multimode and single mode types with different step and graded indices.

### Step and graded index

Optical fiber cables consist of 2 concentric materials, the core and cladding, plus a protective (colored) jacket. The core and the cladding have a different index of refraction, causing the light waves (modes; a mode is a natural wave in the optical fiber) to be reflected back into the core at the boundary. Due to the step change in the index of refraction this type of fiber is referred to as step index. A gradual/parabolic transition between the index of refraction in the core and the coating (referred to as graded index) can be achieved by mixing the materials. In a graded index fiber the modes are gradually diffracted back to the core, leading to propagation-time compensation and significantly higher quality of the light pulse at the outlet compared with a multimode step index fiber, where the different light modes have different signal run times (mode dispersion) with associated front distortion.

### Single mode

Single-mode fibers have a very thin core (9  $\mu\text{m}$ ) and therefore conduct only a single mode of the light used, with high signal quality and virtually without mode dispersion. They are only available as step index fibers. Due to the high signal quality they are suitable for large transmission bandwidths  $> 10 \text{ GHz}\cdot\text{km}$  and distances  $> 50 \text{ km}$ . The refractive index profile of single-mode fibers is dimensioned such that the multipath propagation (intermodal dispersion), which is a problem with multi-mode fibers, is omitted – the signal light propagates in a single-mode fiber only in a single guided fiber mode, hence the designation 'single-mode'. This makes considerably larger transmission distances and/or bandwidths possible, and the limiting effect that arises next is the color distortion of the transmitted mode.

### Multimode

Multimode fiber-optics are manufactured as step index or graded index. Step index multimode fiber cables are suitable for transmission bandwidths up to  $100 \text{ MHz}\cdot\text{km}$  and distances up to 1 km. Graded index multimode fiber cables with core diameters between 50 and 62.5  $\mu\text{m}$  reach transmission bandwidths  $> 1 \text{ GHz}\cdot\text{km}$  and ranges  $> 10 \text{ km}$ . Multimode means that the core of the fiber-optic cable is thick enough to enable several light modes to propagate reflectively in the cable.

There are different types of multimode fiber-optics, which are optimized for different wavelengths or transmission sources. Through the optimization of the fibers for different wavelengths, the attenuation differs with different transmission rates and the bandwidth/length ratio differs for the different fiber types. The exact values must be taken from the data sheet for the selected fiber in order to check whether the use of the selected fiber is wise.

- OM1: 62.5/125  $\mu\text{m}$ , optimized for 1300 nm LEDs
- OM2: 50/125  $\mu\text{m}$ , optimized for 1300 nm LEDs
- OM3: 50/125  $\mu\text{m}$ , optimized for 850 nm VCSEL (vertical-cavity surface-emitting laser)
- OM4: 50/125  $\mu\text{m}$ , optimized for 850 nm VCSEL (vertical-cavity surface-emitting laser)

### 5.2.3 Application with EK1501 and EK1501-0010

The EK1501 / EK1501-0010 is intended for application with optical fiber cables with the following characteristics:

- SC duplex connector
- EK1501: Duplex multimode 50/125  $\mu\text{m}$  or 62.5/125  $\mu\text{m}$  (inner/outer core diameter). The use of both diameters is possible. However, the use of 50/125  $\mu\text{m}$  is recommended due to the lower attenuation.
- EK1501-0010: Duplex single-mode 9/125  $\mu\text{m}$  (inner/outer core diameter). A typically usable cable can be manufactured according to the specification IT-T G.652.D (0.4 dBm/km at 1300 nm).

---

#### ● Recommended connectors

#### **i**

- The use of SC/PC connectors is recommended for connecting to the EK1501/EK1501-0010. The advantage of the "PC" (physical contact) version of this connector is the crowned end face, which allows the region of the fiber core that is relevant to transmission to be optimally joined when the connector is pushed together.
- Other versions include, for instance, the SC/UPC (ultra-polish PC), SC/HRL (high return loss) and the SC/APC plug (angled physical contact). An additional feature of these connectors is that light that is reflected by the connector's end face, which is at an angle of about  $8^\circ$  to the fiber axis, is refracted from the core by the cladding glass into the air. This avoids interference with the data transmission, optimizing the core size of the back-scatter.

In optical fibers the wavelengths 850 nm and 1300 nm are usually used for data transfer. Commercially available fiber-optic cables are usually optimized for application in one of these ranges, since signal attenuation is frequency-dependent (like in copper cable), so that large ranges of several km can be achieved for the respective wavelength. Fiber-optic cables in the 1300 nm window generally have lower attenuation than cables in the 850 nm window.

In the EK1501/EK1501-0010 a transceiver with the wavelength of 1300 nm is used.

---

#### ● Range and bandwidth product

#### **i**

Optical fiber cables are available in different qualities from reputable manufacturers. One of the relevant parameters for the user is the frequency-dependent bandwidth product of a cable, specified in [MHz\*km]. The greater the bandwidth product, the lower the attenuation, and therefore the larger the range that can be achieved with this cable (see ITU-T G-651).

- For achieving the maximum range with the EK1501 / EK1501-0010, optical fibers with a maximum bandwidth product of 1300 nm should therefore be used; we recommended using class OM2 optical fibers (EN50173:2002). Standard optical fiber cables have a minimum bandwidth product of 500 MHz\*km at 1300 nm, higher-quality cables are suitable for distances > 500 m over > 1000 MHz\*km.
- In order to achieve the maximum range, the device to which the EK1501/EK1501-0010 is connected must also support such ranges.

---

#### ● Installation notes

#### **i**

- permitted bending radius
- permitted tensile strength
- sensitivity of the exposed contact ends

Further information can be found in the following documents:

- ITU recommendation ITU-T G.651 - G.655
- EN 50173:2002
- EN 60793-2

**Connecting and releasing the optical fiber cable at the junction****NOTICE****Risk of damage to the cable!**

To disconnect the optical fiber cable always pull the connector to release the locking mechanism - never pull the optical fiber cable itself.

**● Crossover cables**

**i** Not that crossover cables may have to be used for connecting the EK1521, EK1521-0010 with the EK1501/ EK1501-0010.

**Practical tip:**

In many cases the infrared light emission can be made visible via a digital or smartphone camera at the junction or at the coupler (see figure). Avoid 'light meeting light' when connecting the optical fiber cable (Tx → Tx). In this case no connection can be established, and crossover cables must be used (Tx → Rx).



Figure: Visualization of infrared light at the SC duplex connector

**● Use of blind plugs**

**i** To protect the transceiver from environmental influences, unused connection socket should be sealed with the blind plugs provided!



Figure: Blind plugs in unused sockets

### 5.3 Notes for couplers with POF connection

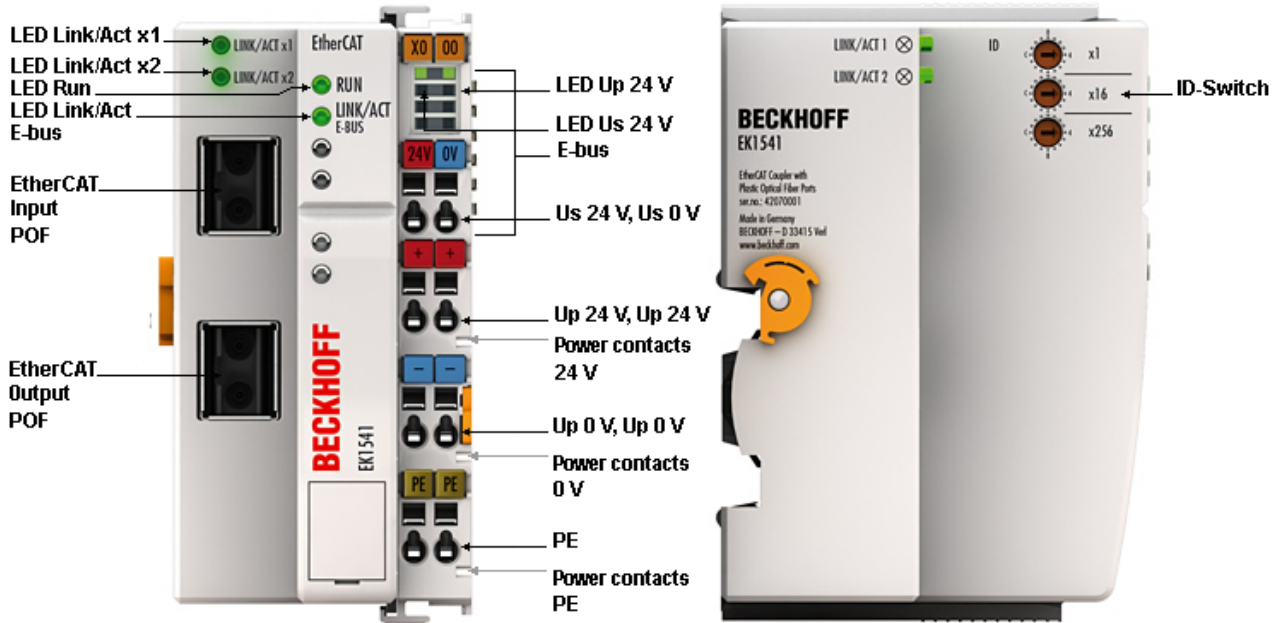

Fig. 50: EK1541

#### 5.3.1 Notes regarding suitable POF cables

##### General information about POF cables

The standard polymer fiber is 1 mm thick and consists of a 0.98 mm thick core made of polymethyl methacrylate (PMMA) as well as a thin sheath. In order to enable the guidance of light using the effect of total reflection in the core, the usually very thin sheath consists of fluorinated PMMA, which has a low refractive index. The core diameters lie between 0.06 and 1 mm, as a result of which simple plug connections are easy to implement. Furthermore, the splicing process often used for the connection of glass fibers and the unnecessarily high expenditure associated with it can usually be dispensed with. The maximum operating temperature of standard POF is approximately 60 °C and has a refraction profile with step index (SI-POF). The refractive index of the core material is around 1.49 and that of the sheath around 1.41. The difference determines the numerical aperture (NA) and thus the maximum propagation angle. With a difference of 5% this angle is about 20 degrees in relation to the fiber axis, which leads to a reduction in the bandwidth.

Due to the simple and almost universally applicable connection techniques compared to glass fibers, POFs are used in particular for short transmission distances, such as inside rooms, technical equipment, mechanical systems or cars.

POFs have an attenuation of about 140 dB/km at a wavelength of 650 Nm, so that a maximum data transmission distance of 50 m can be achieved when used with the EK1541.

Insertion of additional connectors in the route increases the signal attenuation. For each additional plug connector, the maximum permitted distances typically reduces by 6.5 m.

#### 5.3.2 Application with EK1541

##### **i** Recommended plug connectors and POF cables

For the connection of the EK1541 it is recommended to use the connector set [ZS1090-0008](#) [[▶ 89](#)] (Versatile Link Duplex connectors) in conjunction with a duplex polymer fiber with an outside diameter of 2 x 2.2 mm (Z1190), which are available from Beckhoff.

## **i** Installation notes

- permissible bending radius (in general  $r \geq 25$  mm, refer to the manufacturer's data!)
- permitted tensile strength
- sensitivity of the exposed contact ends

### Connecting and releasing the POF cable at the coupler

To connect the cable, insert the plug (available as an accessory in the plug set ZS1090-0008) into the connection opening until it audibly latches.

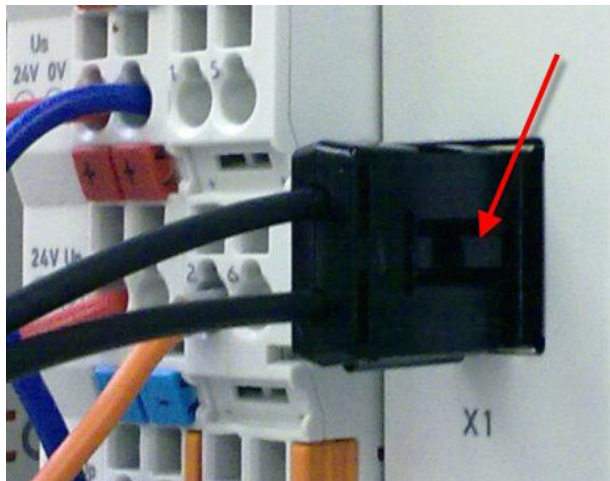

Fig. 51: Latching lug with release catch on the POF duplex plug

To release the connector activate the release device with the latching lug. This can be found on the right-hand side of the connector (see figure).

### NOTICE

#### Risk of damage to the cable!

To release the cable, press the release catch on the plug and pull the plug at the same time – never pull by the POF cable alone!

### NOTICE

#### TX / Rx channel assignment

During cable assembly [▶ 89] note the assignment of the optical channels in the connection sockets. In the EK1541 the light-emitting transmitter channel (Tx) is the lower outlet in the connection sockets.



Figure: Transmitter channels in the EK1541

Be sure to observe the safety instructions [▶ 97] for class 1 lasers!



**NOTICE****Use of blind plugs**

In order to avoid accidents due to glare (Class 1 laser, please observe the [safety instructions \[► 97\]](#)) and to protect the transceiver against environmental influences, unused sockets should be sealed using the blind plugs provided!

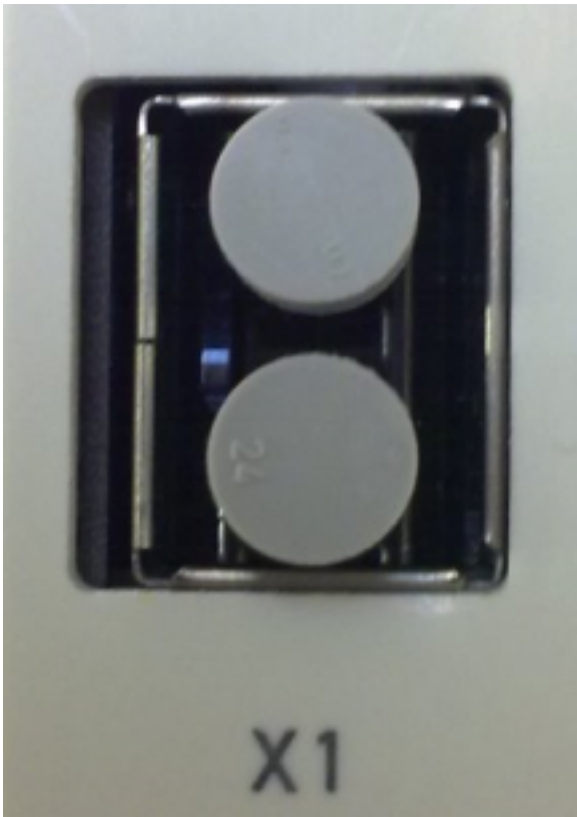

Figure: Blind plugs in unused sockets

### 5.3.3 Notes regarding assembly of POF cables with the connector set ZS1090-0008



Fig. 52: Duplex connector set ZS1090-0008

The duplex connector set ZS1090-0008 from Beckhoff consists of 10 duplex Versatile Link connectors and several sheets of abrasive paper and polishing paper.

## Step-by-step instructions for assembling the POF cable

The following step-by-step guide describes the correct assembly of a POF cable with a Versatile Link duplex connector. The connectors are attached to the cable ends with standard tools such as cutter knife or wire strippers. Polish the assembled cable with the polishing set provided with the connector set, consisting of a plastic sanding gauge, sheets of abrasive paper with grain size 600 and pink polishing sheets. Once assembled, the connector can be used right away.

Materials required:

1. POF cable (Polymeric Optical Fiber, e.g. Z1190 from Beckhoff)
2. Cutter knife or shears
3. Wire strippers
4. Polishing set (included with connector set ZS1090-0008 from Beckhoff)
5. Versatile Link duplex connector (included in connector set ZS1090-0008 from Beckhoff)

### 1. Stripping the POF cable

The cable should be split over a length between 100 mm and 150 mm from the cable end, so that the following steps can be carried out properly.

Once you have shortened the cable to the required length, use the wire strippers to remove approx. 7 mm of the external sheathing of the individual wires. The two cable ends should be stripped over approximately the same length.

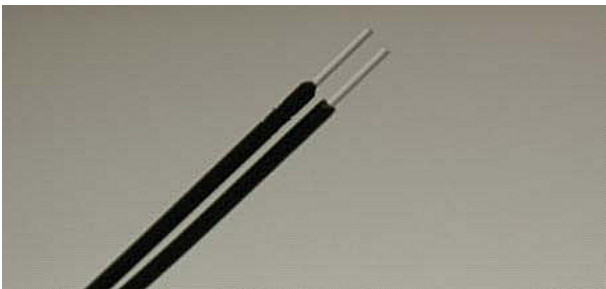

Fig. 53: POF cable stripped over the same length

### 2. Attaching the connector

Push the two cable ends into the connector and the connector back until it stops. The fibers should now protrude no more than 1.5 mm from the front openings.

Close the connector by folding the upper and lower halves together until they engage.

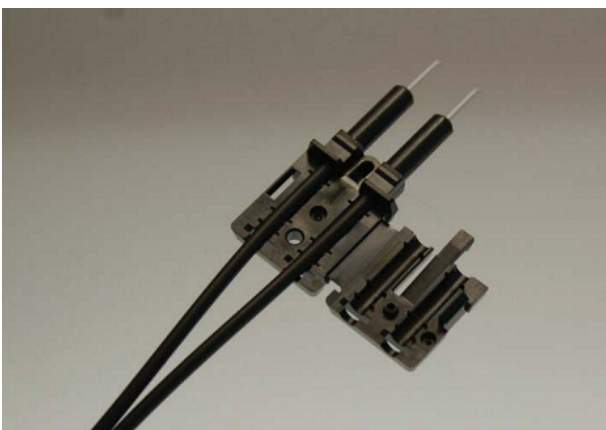

Fig. 54: Cable inserted in the connector

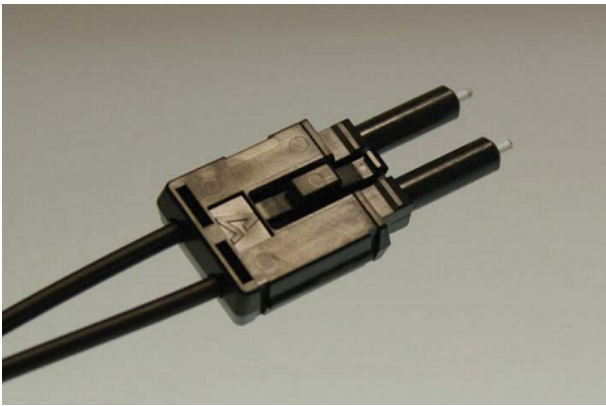

Fig. 55: Closed connector

When inserting the wires into the connector ensure the optical channels are crossed (Tx1 → Rx2; Tx2 → Rx1). The 'nose' at the connector hinge can be used as a guide.

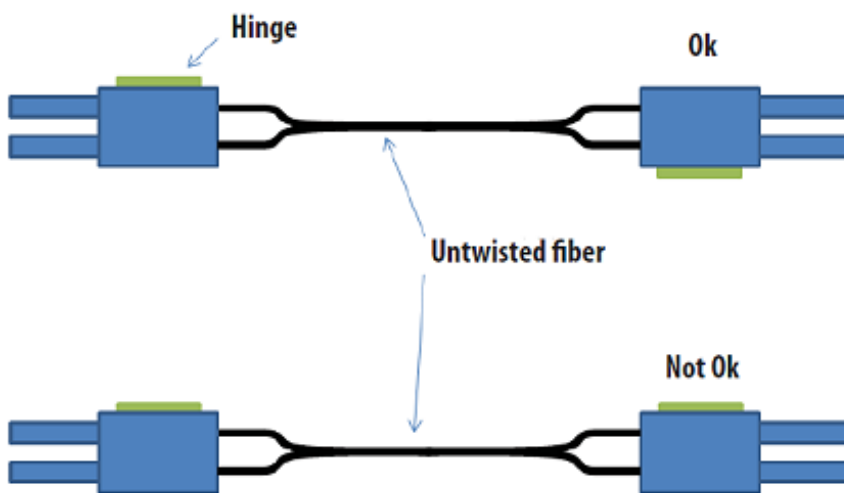

Fig. 56: Correctly connected optical channels

**3. Grinding and polishing**

Any fibers protruding more than 1.5 mm from the connector should be shortened with a cutter knife or a pair of scissors.

Now push the connector fully into the sanding gauge, so that the ends to be polished protrude from the lower side. The sanding gauge is suitable for polishing one or two simplex connectors or a duplex connector.

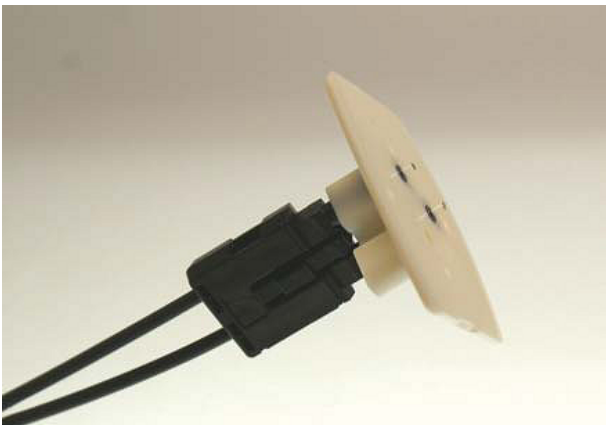

Fig. 57: Sanding gauge with protruding fiber ends

---

**● Wear indicator**

**i** The wear indicator of the sanding gauge consists of four points on the underside. The sanding gauge should be replaced when one of these points is no longer visible.

---

Now press the sanding gauge onto the abrasive paper with uniform pressure and as perpendicular as possible. In order to achieve a uniform result, use the abrasive paper in the form of a figure of 8, until the fibers are flush with the sanding gauge. Then clean the sanding gauge and the connector from below with a soft, dry cloth.

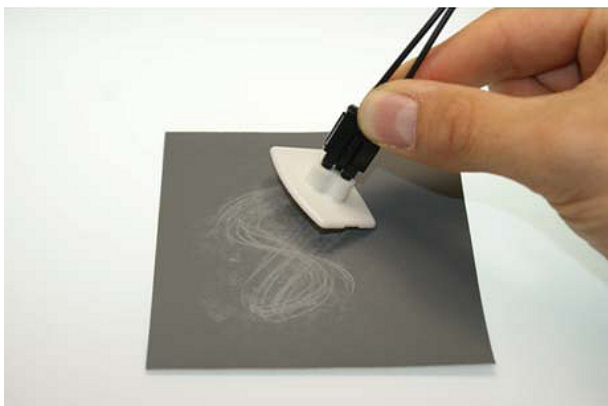

Fig. 58: Polishing in the form of a figure of 8

**4. Fine polishing**

Now use the pink polishing sheet for fine polishing in the same manner. Apply the connector with the sanding gauge to the matt side of the polishing sheet with slight pressure and polish in the form of a figure of 8 up to 25 times. After the procedure the fiber end should be flat, smooth and clean.

**● Improving the transfer performance by fine polishing**

**i** Fine polishing with a polishing sheet can improve the transfer performance between the transmitter and the receiver or in the cable joint by up to 0.5 dB compared with treatment with abrasive paper alone. For short transfer distances the polishing step can be omitted.

---

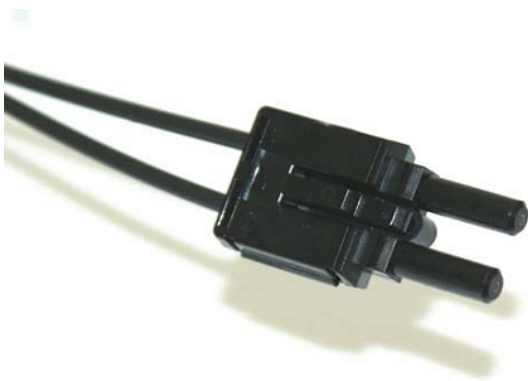

Fig. 59: Fine-polished fibers in the connector

## 6 Diagnostic LEDs

### 6.1 EK1100, EK1100-0008

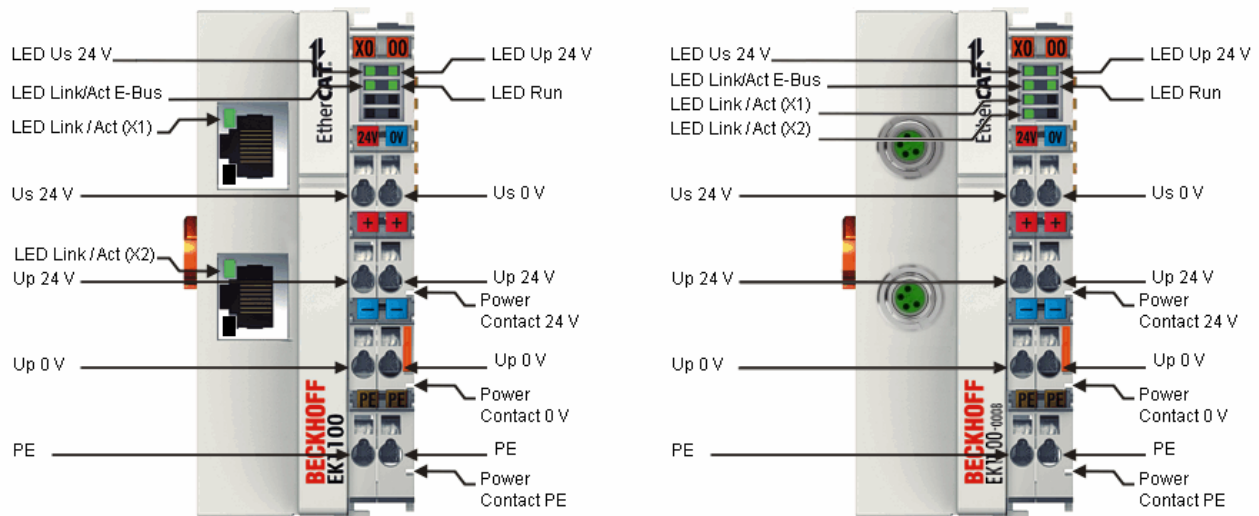

Fig. 60: Diagnostic LEDs EK1100, EK1100-0008

#### LEDs for power supply diagnostics

LED	Display	State	Description
Us	green	off	No operating voltage present at the Bus Coupler
		on	24 V <sub>DC</sub> operating voltage present at the Bus Coupler
Up	green	off	No power supply present at the power contacts
		on	24 V <sub>DC</sub> power supply present at the power contacts

#### Diagnostic LEDs for the EtherCAT State Machine/PLC

LED	Display	State	Description	
RUN	green	off	Init	The Bus Coupler is in initialization state
		flashing	Pre-Operational	The Bus Coupler is in <i>pre-operational</i> state
		single flash	Safe-Operational	The Bus Coupler is in <i>safe-operational</i> state
		on	Operational	The Bus Coupler is in <i>operational</i> state
		flickers	Bootstrap	Firmware is being loaded.

#### LEDs for fieldbus diagnosis

LED	Display	State	Description	
LINK/ACT (X1 IN)	green	off	No connection on the incoming EtherCAT strand	
		on	Preceding EtherCAT device connected	
		flashing	active	Communication with preceding EtherCAT device
LINK/ACT (X2 OUT)	green	off	No connection on the outgoing EtherCAT strand	
		on	Following EtherCAT device connected	
		flashing	active	Communication with following EtherCAT device
LINK / ACT E-bus	green	off	No connection to internal E-bus	
		on	linked	Connection to internal E-bus
		flashing	active	Connection/communication internal E-bus

## 6.2 EK1101-xxxx

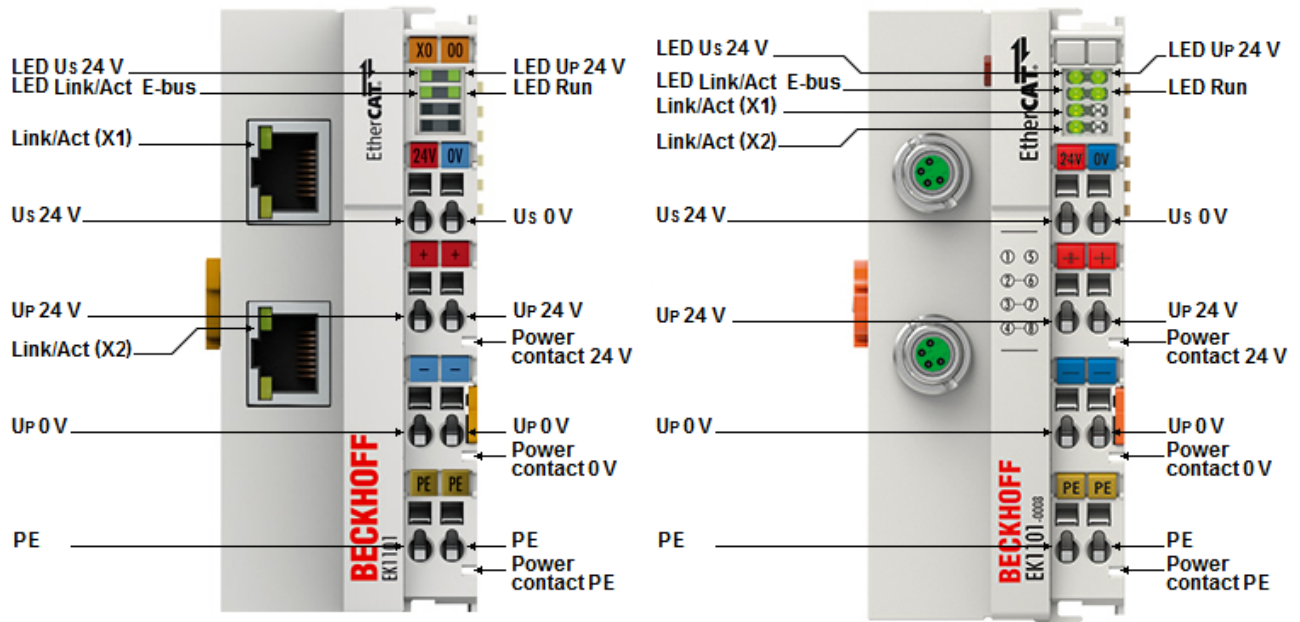

Fig. 61: Diagnostic LEDs EK1101-00x0, EK1101-0008

### LEDs for power supply diagnostics

LED	Display	State	Description
Us	green	off	No operating voltage present at the Bus Coupler
		on	24 V <sub>DC</sub> operating voltage present at the Bus Coupler
Up	green	off	No power supply present at the power contacts
		on	24 V <sub>DC</sub> power supply present at the power contacts

### Diagnostic LEDs for the EtherCAT State Machine/PLC

LED	Display	State	Description
RUN	green	off	Init The Bus Coupler is in initialization state
		flashing	Pre-Operational The Bus Coupler is in <i>pre-operational</i> state
		single flash	Safe-Operational The Bus Coupler is in <i>safe-operational</i> state
		on	Operational The Bus Coupler is in <i>operational</i> state
		flickers	Bootstrap Firmware is being loaded.

### LEDs for fieldbus diagnosis

LED	Display	State	Description
LINK/ACT (X1 IN)	green	off	No connection on the incoming EtherCAT strand
		on	Preceding EtherCAT device connected
		flashing	Communication with preceding EtherCAT device
LINK/ACT (X2 OUT)	green	off	No connection on the outgoing EtherCAT strand
		on	Following EtherCAT device connected
		flashing	Communication with following EtherCAT device
LINK / ACT E-bus	green	off	No connection to internal E-bus
		on	Connection to internal E-bus
		flashing	Connection/communication internal E-bus

### 6.3 EK1501, EK1501-0010, EK1541

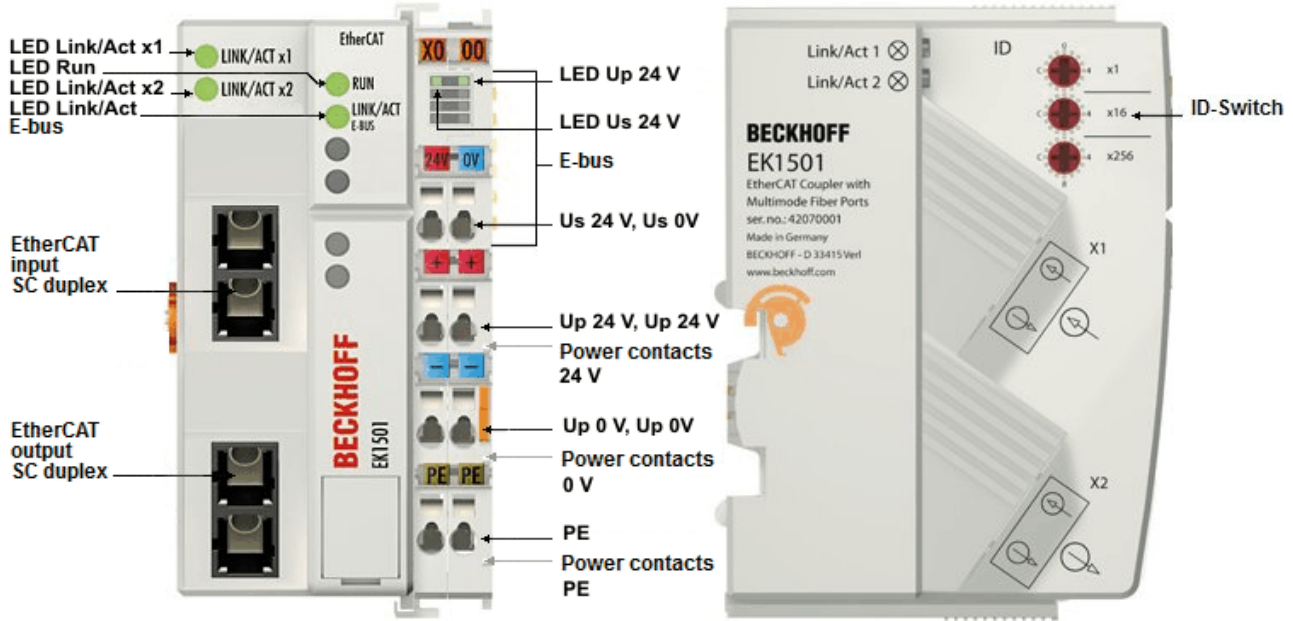

Fig. 62: Diagnostic LEDs for Bus Coupler EK15x1-00x0

#### LEDs for power supply diagnostics

LED	Display	State	Description
Us	green	off	No operating voltage present at the Bus Coupler
		on	24 V <sub>DC</sub> operating voltage present at the Bus Coupler
Up	green	off	No power supply present at the power contacts
		on	24 V <sub>DC</sub> power supply present at the power contacts

#### Diagnostic LEDs for the EtherCAT State Machine/PLC

LED	Display	State	Description	
RUN	green	off	The Bus Coupler is in initialization state	
		flashing	Pre-Operational	The Bus Coupler is in <i>pre-operational</i> state
		single flash	Safe-Operational	The Bus Coupler is in <i>safe-operational</i> state
		on	Operational	The Bus Coupler is in <i>operational</i> state
		flickers	Bootstrap	Firmware is being loaded.

#### LEDs for fieldbus diagnosis

LED	Display	State	Description	
LINK/ACT (X1 IN)	green	off	No connection on the incoming EtherCAT strand	
		on	Preceding EtherCAT device connected	
		flashing	active	Communication with preceding EtherCAT device
LINK/ACT (X2 OUT)	green	off	No connection on the outgoing EtherCAT strand	
		on	Following EtherCAT device connected	
		flashing	active	Communication with following EtherCAT device
LINK / ACT E-bus	green	off	No connection to internal E-bus	
		on	linked	Connection to internal E-bus
		flashing	active	Connection/communication internal E-bus

## 7 Appendix

### 7.1 Volatility

If there are requirements concerning the volatility of products in your application, for example of the U.S. Department of Defense or similar authorities or security organizations, the following process applies:

The product has both volatile and non-volatile components. Volatile components lose their data immediately after removing power. Non-volatile components keep the data even after loss of power.

If there is customer specific data saved on the product, it cannot be ensured that this data might not be restored through for example forensic measures, even after the data is deleted through the provided tool chain. If this data is confidential, the scrapping of the product after usage is recommended to protect this data.



## 7.2 Safety instructions and behavioral rules for Class 1 laser

### ⚠ CAUTION

**Class 1 laser product – danger of accident due to glare!**



The following laser-specific behavioral rules are to be followed for the Class 1 laser products described in this document:

- The laser beam may not be directed toward persons, since accidents may be caused by glare.
- Do not look into the direct or reflected beam.
- If laser radiation meets the eye, the eyes must be consciously closed and the head turned away from the beam immediately.
- When using the laser, no optical instruments may be used to view the radiation source, since this can lead to exposure limit values being exceeded.
- Manipulations (modifications) of the laser device are not permitted.

## **7.3 Firmware compatibility**

The EK110x and EK15xx Couplers have no firmware.

## 7.4 Firmware Update EL/ES/EM/ELM/EPxxxx

This section describes the device update for Beckhoff EtherCAT slaves from the EL/ES, ELM, EM, EK and EP series. A firmware update should only be carried out after consultation with Beckhoff support.

### NOTICE

#### Only use TwinCAT 3 software!

A firmware update of Beckhoff IO devices must only be performed with a TwinCAT 3 installation. It is recommended to build as up-to-date as possible, available for free download on the [Beckhoff website](#).

To update the firmware, TwinCAT can be operated in the so-called FreeRun mode, a paid license is not required.

The device to be updated can usually remain in the installation location, but TwinCAT has to be operated in the FreeRun. Please make sure that EtherCAT communication is trouble-free (no LostFrames etc.).

Other EtherCAT master software, such as the EtherCAT Configurator, should not be used, as they may not support the complexities of updating firmware, EEPROM and other device components.

### Storage locations

An EtherCAT slave stores operating data in up to three locations:

- Each EtherCAT slave has a device description, consisting of identity (name, product code), timing specifications, communication settings, etc.  
This device description (ESI; EtherCAT Slave Information) can be downloaded from the Beckhoff website in the download area as a [zip file](#) and used in EtherCAT masters for offline configuration, e.g. in TwinCAT.  
Above all, each EtherCAT slave carries its device description (ESI) electronically readable in a local memory chip, the so-called **ESI EEPROM**. When the slave is switched on, this description is loaded locally in the slave and informs it of its communication configuration; on the other hand, the EtherCAT master can identify the slave in this way and, among other things, set up the EtherCAT communication accordingly.

### NOTICE

#### Application-specific writing of the ESI-EEPROM

The ESI is developed by the device manufacturer according to ETG standard and released for the corresponding product.

- Meaning for the ESI file: Modification on the application side (i.e. by the user) is not permitted.
- Meaning for the ESI EEPROM: Even if a writeability is technically given, the ESI parts in the EEPROM and possibly still existing free memory areas must not be changed beyond the normal update process. Especially for cyclic memory processes (operating hours counter etc.), dedicated memory products such as EL6080 or IPC's own NOVDRAM must be used.

- Depending on functionality and performance EtherCAT slaves have one or several local controllers for processing I/O data. The corresponding program is the so-called **firmware** in \*.efw format.
- In some EtherCAT slaves the EtherCAT communication may also be integrated in these controllers. In this case the controller is usually a so-called **FPGA** chip with \*.rbf firmware.

Customers can access the data via the EtherCAT fieldbus and its communication mechanisms. Acyclic mailbox communication or register access to the ESC is used for updating or reading of these data.

The TwinCAT System Manager offers mechanisms for programming all three parts with new data, if the slave is set up for this purpose. Generally the slave does not check whether the new data are suitable, i.e. it may no longer be able to operate if the data are unsuitable.

### Simplified update by bundle firmware

The update using so-called **bundle firmware** is more convenient: in this case the controller firmware and the ESI description are combined in a \*.efw file; during the update both the firmware and the ESI are changed in the terminal. For this to happen it is necessary

- for the firmware to be in a packed format: recognizable by the file name, which also contains the revision number, e.g. ELxxxx-xxxx\_REV0016\_SW01.efw

- for password=1 to be entered in the download dialog. If password=0 (default setting) only the firmware update is carried out, without an ESI update.
- for the device to support this function. The function usually cannot be retrofitted; it is a component of many new developments from year of manufacture 2016.

Following the update, its success should be verified

- ESI/Revision: e.g. by means of an online scan in TwinCAT ConfigMode/FreeRun – this is a convenient way to determine the revision
- Firmware: e.g. by looking in the online CoE of the device

### NOTICE

#### Risk of damage to the device!

✓ Note the following when downloading new device files

- Firmware downloads to an EtherCAT device must not be interrupted
  - Flawless EtherCAT communication must be ensured. CRC errors or LostFrames must be avoided.
  - The power supply must adequately dimensioned. The signal level must meet the specification.
- ⇒ In the event of malfunctions during the update process the EtherCAT device may become unusable and require re-commissioning by the manufacturer.

## 7.4.1 Device description ESI file/XML

### NOTICE

#### Attention regarding update of the ESI description/EEPROM

Some slaves have stored calibration and configuration data from the production in the EEPROM. These are irretrievably overwritten during an update.

The ESI device description is stored locally on the slave and loaded on start-up. Each device description has a unique identifier consisting of slave name (9 characters/digits) and a revision number (4 digits). Each slave configured in the System Manager shows its identifier in the EtherCAT tab:

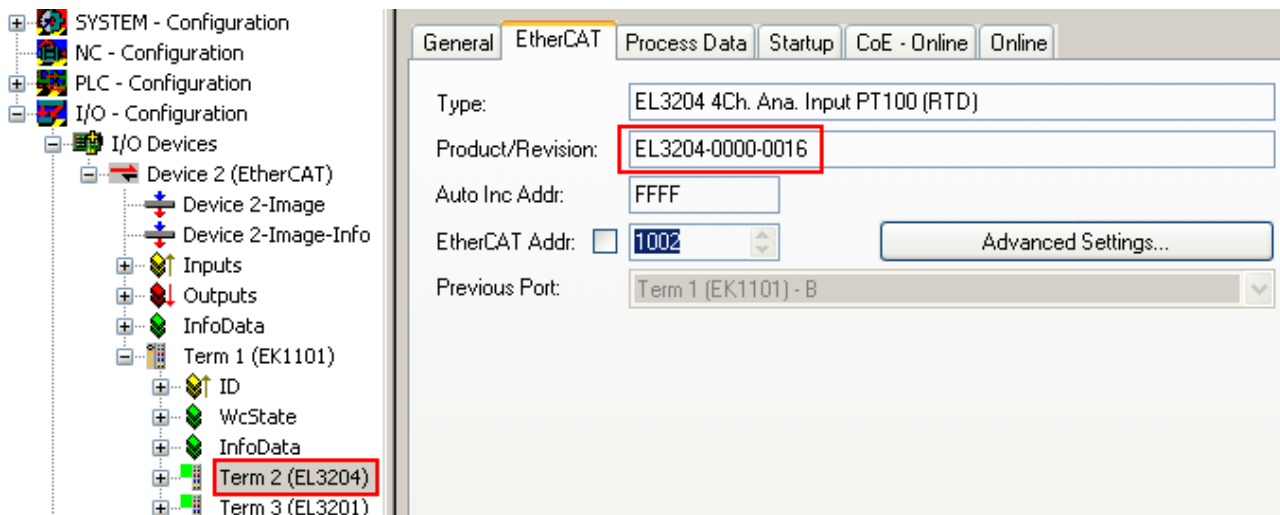

Fig. 63: Device identifier consisting of name EL3204-0000 and revision -0016

The configured identifier must be compatible with the actual device description used as hardware, i.e. the description which the slave has loaded on start-up (in this case EL3204). Normally the configured revision must be the same or lower than that actually present in the terminal network.

For further information on this, please refer to the [EtherCAT system documentation](#).

**i Update of XML/ESI description**

The device revision is closely linked to the firmware and hardware used. Incompatible combinations lead to malfunctions or even final shutdown of the device. Corresponding updates should only be carried out in consultation with Beckhoff support.

**Display of ESI slave identifier**

The simplest way to ascertain compliance of configured and actual device description is to scan the EtherCAT boxes in TwinCAT mode Config/FreeRun:

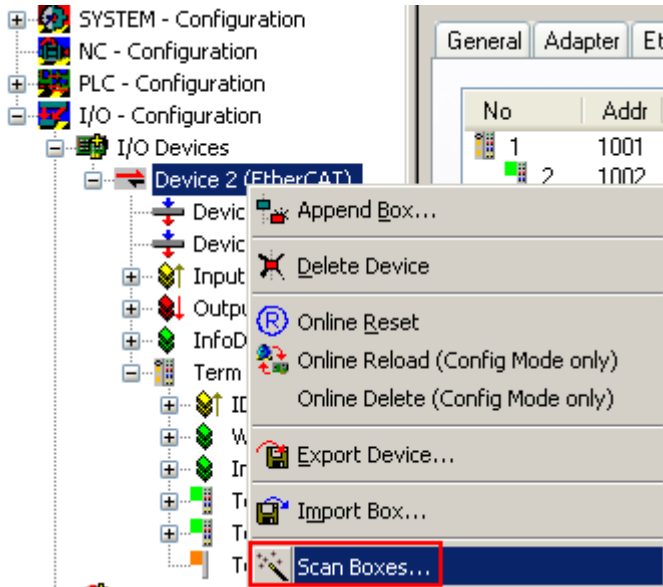

Fig. 64: Scan the subordinate field by right-clicking on the EtherCAT device

If the found field matches the configured field, the display shows



Fig. 65: Configuration is identical

otherwise a change dialog appears for entering the actual data in the configuration.

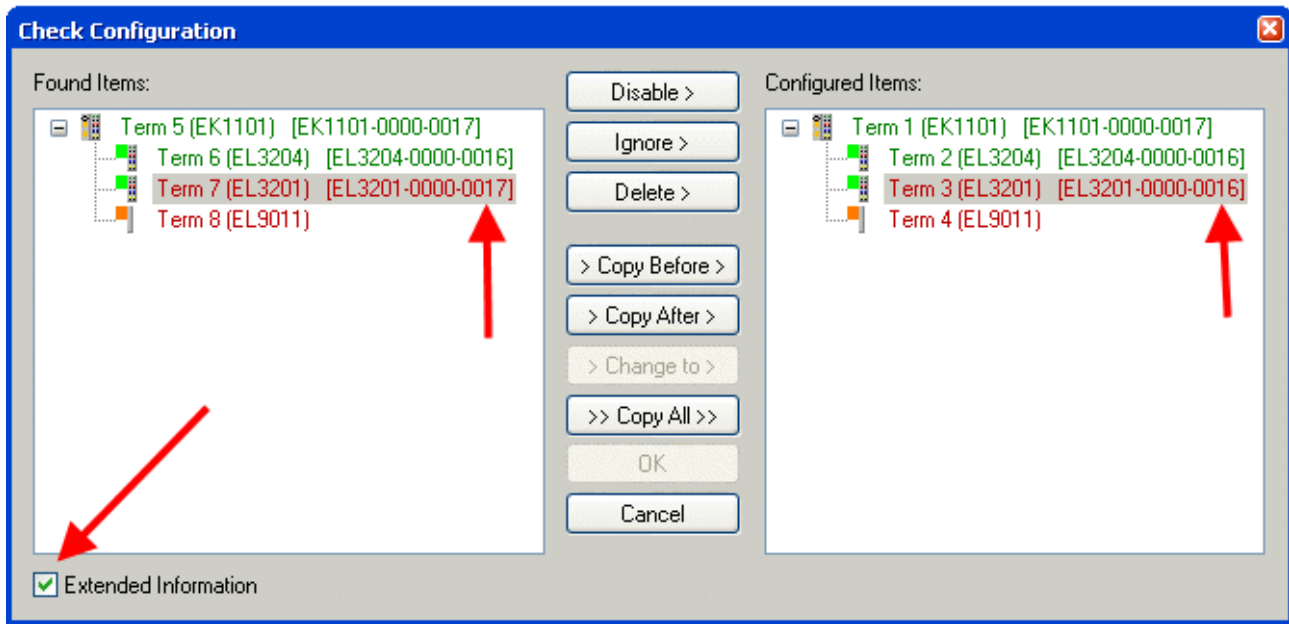

Fig. 66: Change dialog

In this example in Fig. *Change dialog*, an EL3201-0000-0017 was found, while an EL3201-0000-0016 was configured. In this case the configuration can be adapted with the *Copy Before* button. The *Extended Information* checkbox must be set in order to display the revision.

**Changing the ESI slave identifier**

The ESI/EEPROM identifier can be updated as follows under TwinCAT:

- Trouble-free EtherCAT communication must be established with the slave.
- The state of the slave is irrelevant.
- Right-clicking on the slave in the online display opens the *EEPROM Update* dialog, Fig. *EEPROM Update*

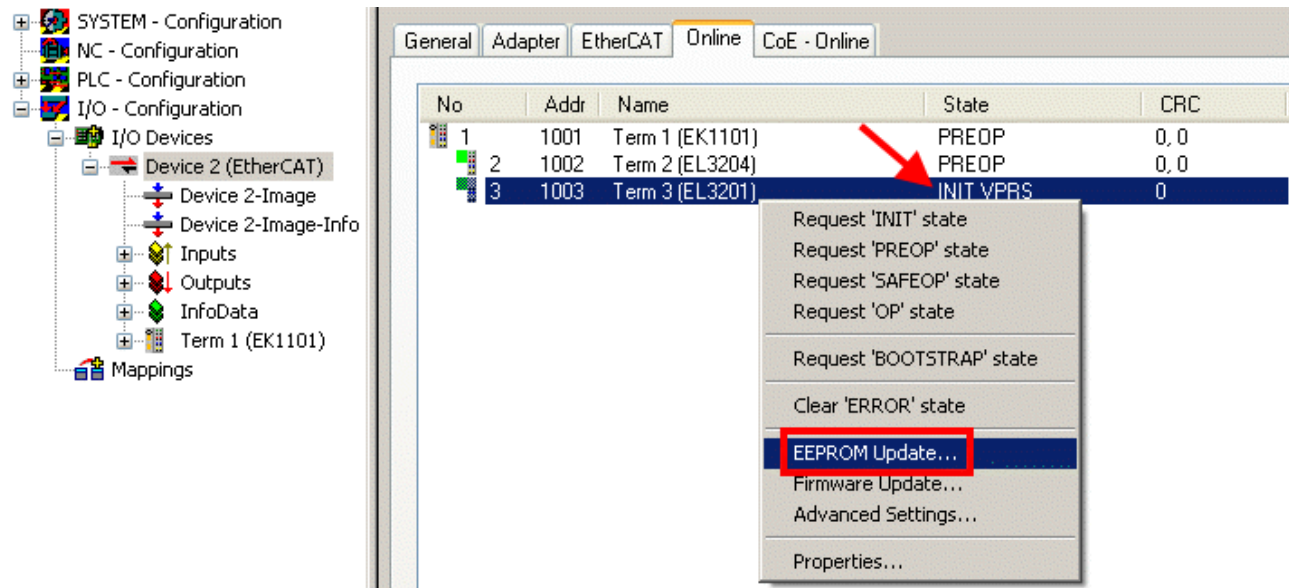

Fig. 67: EEPROM Update

The new ESI description is selected in the following dialog, see Fig. *Selecting the new ESI*. The checkbox *Show Hidden Devices* also displays older, normally hidden versions of a slave.

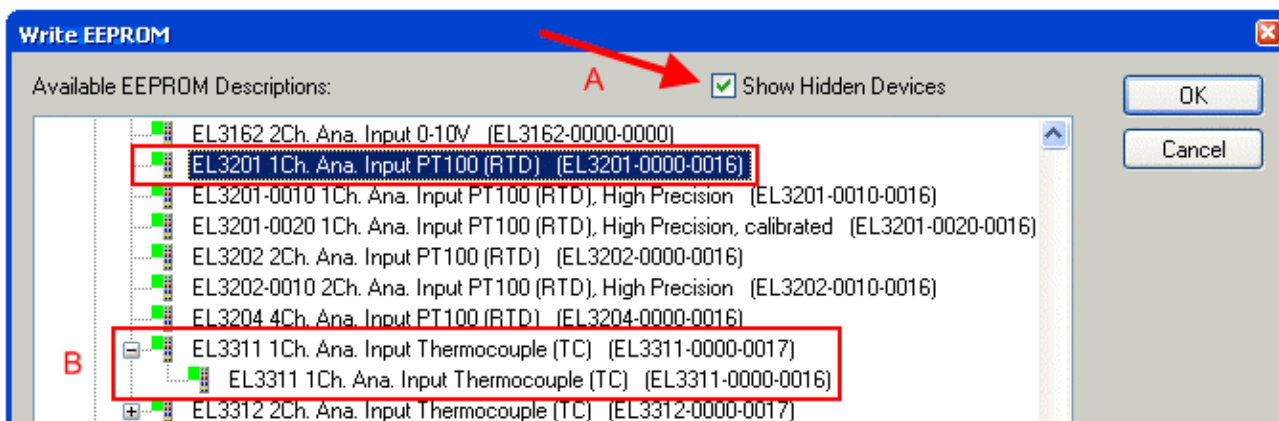

Fig. 68: Selecting the new ESI

A progress bar in the System Manager shows the progress. Data are first written, then verified.

**i** **The change only takes effect after a restart.**

Most EtherCAT devices read a modified ESI description immediately or after startup from the INIT. Some communication settings such as distributed clocks are only read during power-on. The EtherCAT slave therefore has to be switched off briefly in order for the change to take effect.

## 7.4.2 Firmware explanation

### Determining the firmware version

#### Determining the version via the System Manager

The TwinCAT System Manager shows the version of the controller firmware if the master can access the slave online. Click on the E-Bus Terminal whose controller firmware you want to check (in the example terminal 2 (EL3204)) and select the tab *CoE Online* (CAN over EtherCAT).

**i** **CoE Online and Offline CoE**

Two CoE directories are available:

- **online:** This is offered in the EtherCAT slave by the controller, if the EtherCAT slave supports this. This CoE directory can only be displayed if a slave is connected and operational.
- **offline:** The EtherCAT Slave Information ESI/XML may contain the default content of the CoE. This CoE directory can only be displayed if it is included in the ESI (e.g. "Beckhoff EL5xxx.xml").

The Advanced button must be used for switching between the two views.

In Fig. *Display of EL3204 firmware version* the firmware version of the selected EL3204 is shown as 03 in CoE entry 0x100A.

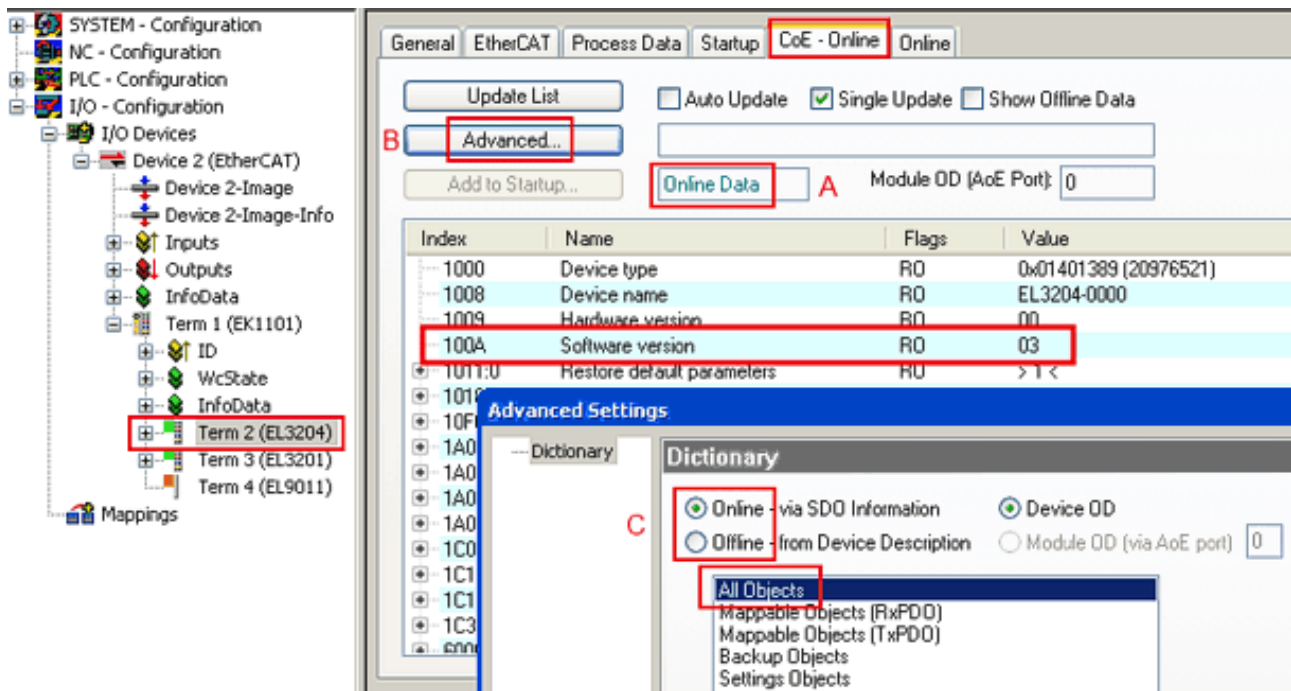

Fig. 69: Display of EL3204 firmware version

In (A) TwinCAT 2.11 shows that the Online CoE directory is currently displayed. If this is not the case, the Online directory can be loaded via the *Online* option in Advanced Settings (B) and double-clicking on *All Objects*.

### 7.4.3 Updating controller firmware \*.efw

#### ● CoE directory

**i** The Online CoE directory is managed by the controller and stored in a dedicated EEPROM, which is generally not changed during a firmware update.

Switch to the *Online* tab to update the controller firmware of a slave, see Fig. *Firmware Update*.



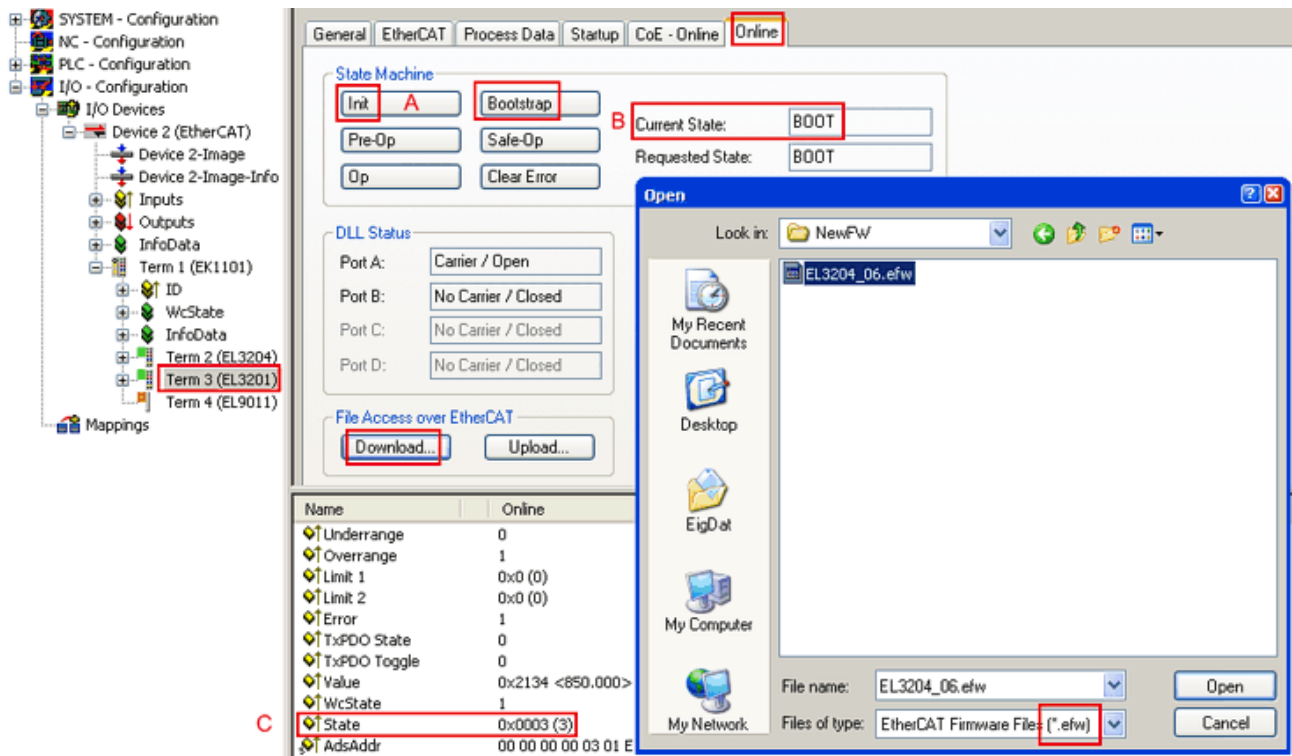
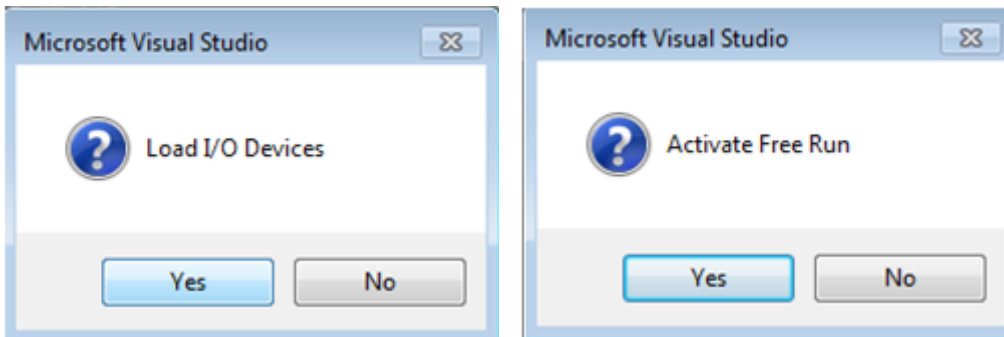

Fig. 70: Firmware Update

Proceed as follows, unless instructed otherwise by Beckhoff support. Valid for TwinCAT 2 and 3 as EtherCAT master.

- Switch TwinCAT system to ConfigMode/FreeRun with cycle time  $\geq 1$  ms (default in ConfigMode is 4 ms). A FW-Update during real time operation is not recommended.



- Switch EtherCAT Master to PreOP

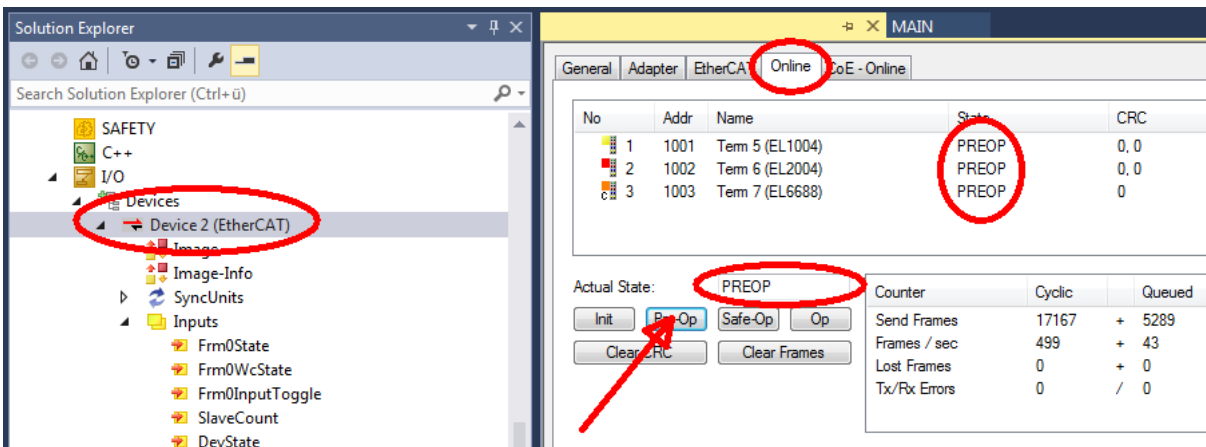

- Switch slave to INIT (A)
- Switch slave to BOOTSTRAP

- Check the current status (B, C)
- Download the new \*efw file (wait until it ends). A password will not be necessary usually.



- After the download switch to INIT, then PreOP
- Switch off the slave briefly (don't pull under voltage!)
- Check within CoE 0x100A, if the FW status was correctly overtaken.

#### 7.4.4 FPGA firmware \*.rbf

If an FPGA chip deals with the EtherCAT communication an update may be accomplished via an \*.rbf file.

- Controller firmware for processing I/O signals
- FPGA firmware for EtherCAT communication (only for terminals with FPGA)

The firmware version number included in the terminal serial number contains both firmware components. If one of these firmware components is modified this version number is updated.

##### Determining the version via the System Manager

The TwinCAT System Manager indicates the FPGA firmware version. Click on the Ethernet card of your EtherCAT strand (Device 2 in the example) and select the *Online* tab.

The *Reg:0002* column indicates the firmware version of the individual EtherCAT devices in hexadecimal and decimal representation.

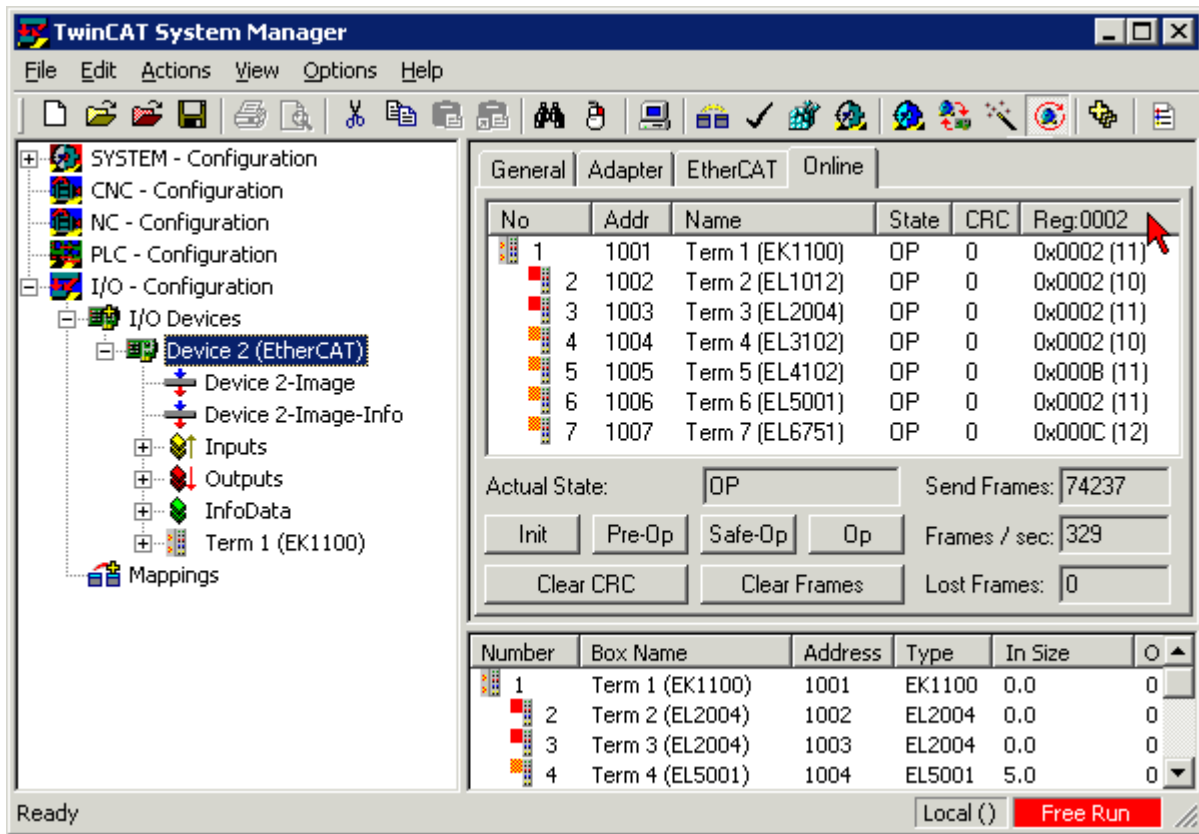

Fig. 71: FPGA firmware version definition

If the column *Reg:0002* is not displayed, right-click the table header and select *Properties* in the context menu.

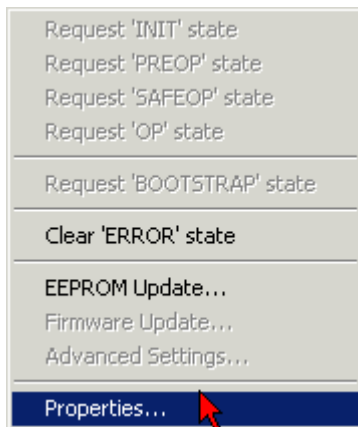

Fig. 72: Context menu *Properties*

The *Advanced Settings* dialog appears where the columns to be displayed can be selected. Under *Diagnosis/Online View* select the *'0002 ETxxxx Build'* check box in order to activate the FPGA firmware version display.

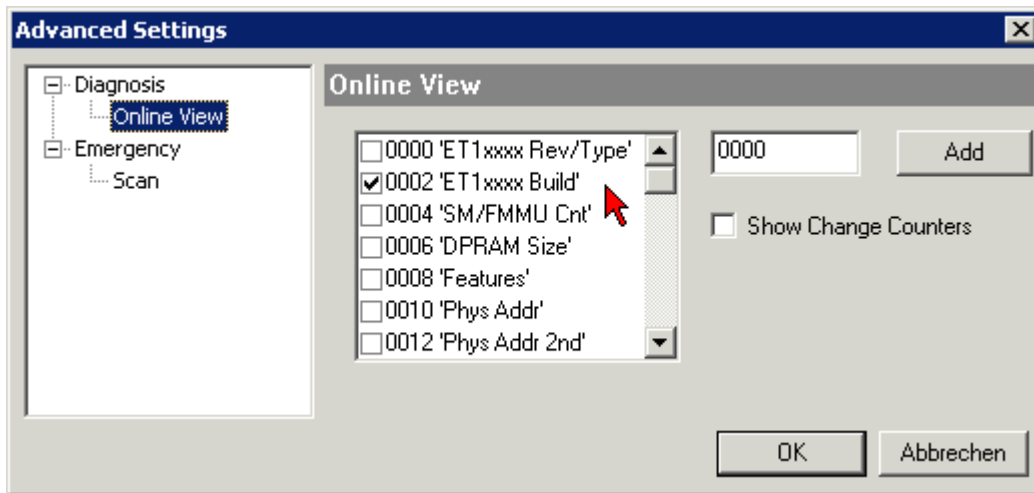

Fig. 73: Dialog *Advanced Settings*

### Update

For updating the FPGA firmware

- of an EtherCAT coupler the coupler must have FPGA firmware version 11 or higher;
- of an E-Bus Terminal the terminal must have FPGA firmware version 10 or higher.

Older firmware versions can only be updated by the manufacturer!

### Updating an EtherCAT device

The following sequence order have to be met if no other specifications are given (e.g. by the Beckhoff support):

- Switch TwinCAT system to ConfigMode/FreeRun with cycle time  $\geq 1$  ms (default in ConfigMode is 4 ms). A FW-Update during real time operation is not recommended.

- In the TwinCAT System Manager select the terminal for which the FPGA firmware is to be updated (in the example: Terminal 5: EL5001) and click the *Advanced Settings* button in the *EtherCAT* tab:

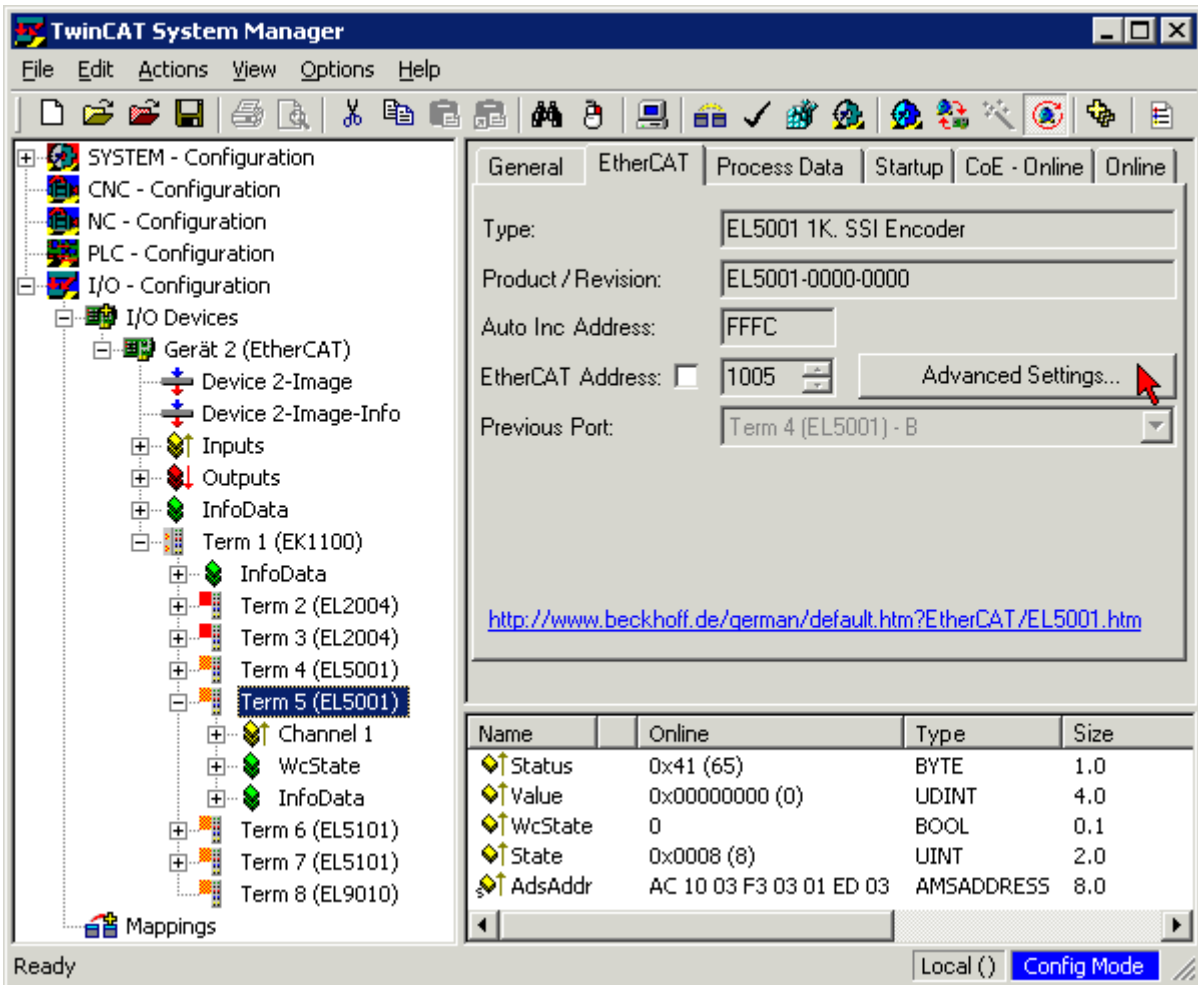

- The *Advanced Settings* dialog appears. Under *ESC Access/E<sup>2</sup>PROM/FPGA* click on *Write FPGA* button:

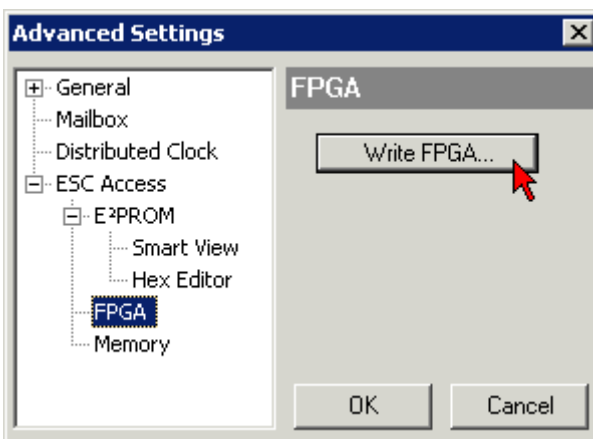

- Select the file (\*.rbf) with the new FPGA firmware, and transfer it to the EtherCAT device:

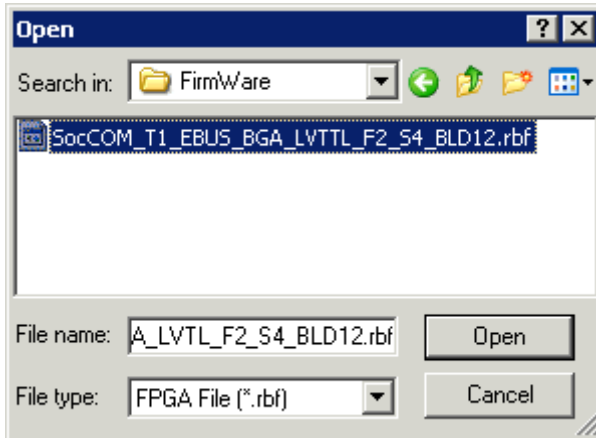

- Wait until download ends
- Switch slave current less for a short time (don't pull under voltage!). In order to activate the new FPGA firmware a restart (switching the power supply off and on again) of the EtherCAT device is required.
- Check the new FPGA status

### NOTICE

#### **Risk of damage to the device!**

A download of firmware to an EtherCAT device must not be interrupted in any case! If you interrupt this process by switching off power supply or disconnecting the Ethernet link, the EtherCAT device can only be recommissioned by the manufacturer!

## 7.4.5 Simultaneous updating of several EtherCAT devices

The firmware and ESI descriptions of several devices can be updated simultaneously, provided the devices have the same firmware file/ESI.

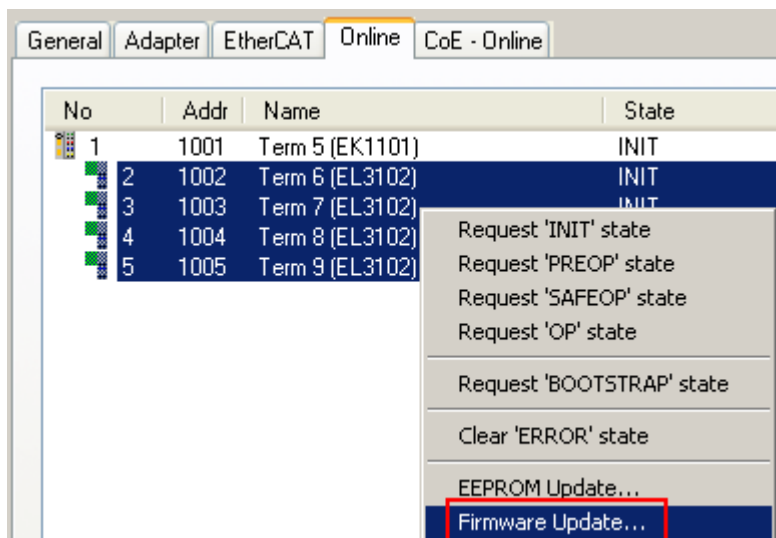

Fig. 74: Multiple selection and firmware update

Select the required slaves and carry out the firmware update in BOOTSTRAP mode as described above.

## 7.5 Support and Service

Beckhoff and their partners around the world offer comprehensive support and service, making available fast and competent assistance with all questions related to Beckhoff products and system solutions.

### Beckhoff's branch offices and representatives

Please contact your Beckhoff branch office or representative for local support and service on Beckhoff products!

The addresses of Beckhoff's branch offices and representatives round the world can be found on her internet pages: [www.beckhoff.com](http://www.beckhoff.com)

You will also find further documentation for Beckhoff components there.

### Support

The Beckhoff Support offers you comprehensive technical assistance, helping you not only with the application of individual Beckhoff products, but also with other, wide-ranging services:

- support
- design, programming and commissioning of complex automation systems
- and extensive training program for Beckhoff system components

Hotline: +49 5246 963 157  
e-mail: [support@beckhoff.com](mailto:support@beckhoff.com)  
web: [www.beckhoff.com/support](http://www.beckhoff.com/support)

### Service

The Beckhoff Service Center supports you in all matters of after-sales service:

- on-site service
- repair service
- spare parts service
- hotline service

Hotline: +49 5246 963 460  
e-mail: [service@beckhoff.com](mailto:service@beckhoff.com)  
web: [www.beckhoff.com/service](http://www.beckhoff.com/service)

### Headquarters Germany

Beckhoff Automation GmbH & Co. KG

Hülshorstweg 20  
33415 Verl  
Germany

Phone: +49 5246 963 0  
e-mail: [info@beckhoff.com](mailto:info@beckhoff.com)  
web: [www.beckhoff.com](http://www.beckhoff.com)





More Information:  
[www.beckhoff.com/EK1xxx](http://www.beckhoff.com/EK1xxx)

Beckhoff Automation GmbH & Co. KG  
Hülshorstweg 20  
33415 Verl  
Germany  
Phone: +49 5246 9630  
[info@beckhoff.com](mailto:info@beckhoff.com)  
[www.beckhoff.com](http://www.beckhoff.com)

