

A

B

C

D

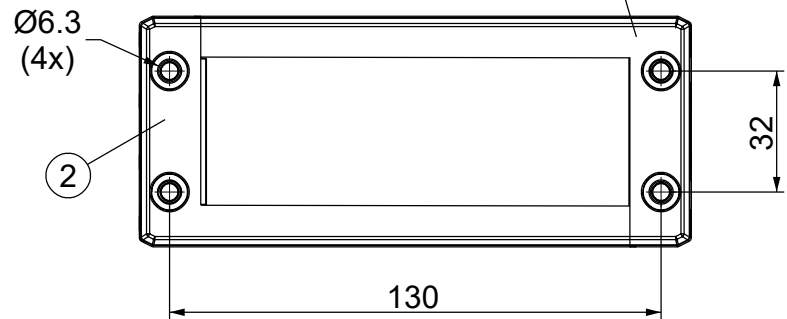
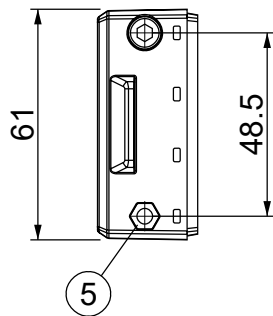
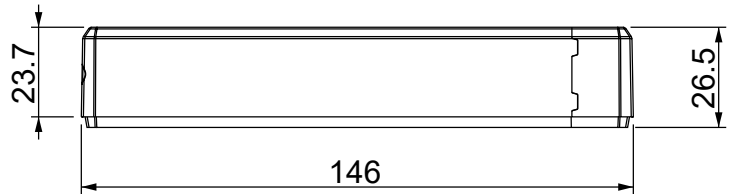
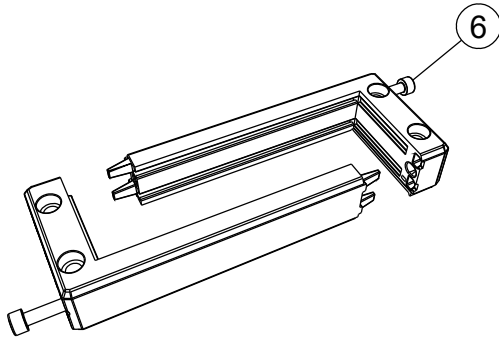
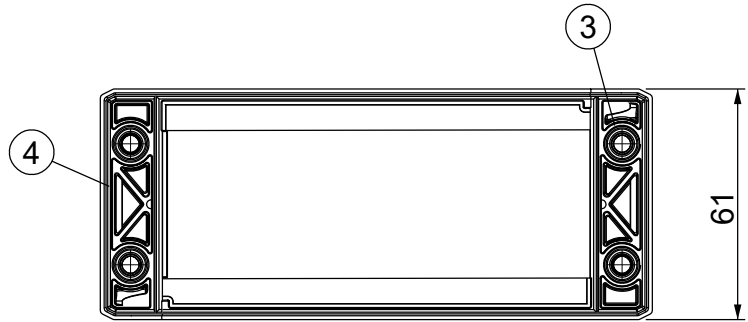
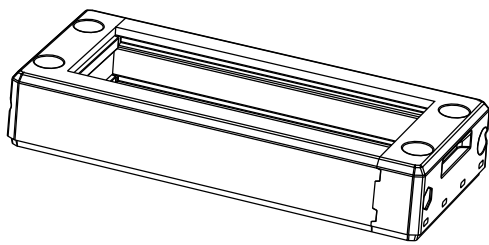

Id	Descrizione	Materiale	Q.tà
1	DES 24 Superiore	PP + GF	1
2	DES 24 Inferiore	PP + GF	1
3	DES 24 guarnizione sup.	TPE	1
4	DES 24 guarnizione inf.	TPE	1
5	Dado (Finit. Black Dacromet)	A2(SS304)	2
6	Vite TCEI M5x0.8 L=140	A2(SS304)	2

	IP66	NEMA 4X	NEMA 12	HL3 EN 45545-2	Marine Type					IK10			+155 -40 °C	
--	-------------	----------------	----------------	--------------------------	--------------------	--	--	--	--	-------------	--	--	----------------	--

Infiammabilità: UL94-V0, autoestinguente
Temperatura: -40°C ... +155°C
Proprietà: senza alogeni, senza siliconi

Apertura consigliata:
112 x 39 mm

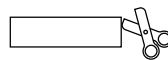

Disponibile versione ATEX:
DES 24 A - 1731310024

Disponibile con inserti filettati:
DES 24 FT - 1731410024

Codice / Code

1731010024

Descrizione / Description

DES 24

Rev.

001

Materiale / Material

see table

Colore / Color

Nero

Peso / Weight (g)

156.6

Unità di misura / Measure units

mm

Formato / Format

A4

Scala / Scale

1:2



Data / Date
26/07/2023

Numero foglio / Sheet number

-

Numero progetto / Project number

-

Disegn. / Drawn

ravezzano@detas.com

Note / Notes

-

QUESTO DISEGNO E LE SUE INFORMAZIONI SONO STRETTAMENTE RISERVATE DI PROPRIETÀ DETAS SPA. NON UTILIZZARE PER SCOPI DIVERSI DA QUELLI PER CUI SONO STATE FORNITE. DO NOT SCALE DRAWING.

A

B

C

D